

Installation Manual

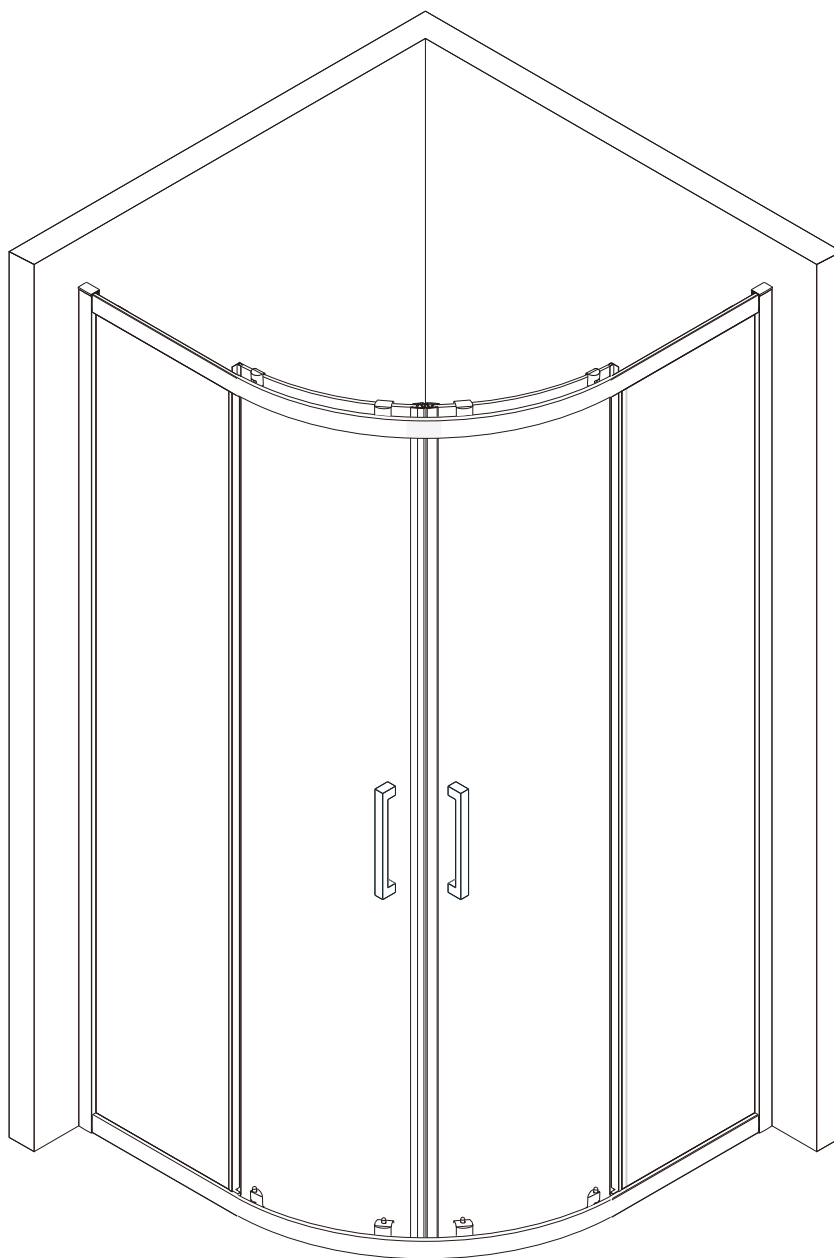

Apply for following models:

**41120/41121/41122/41123/41124/41125
41137/41138/41169 /41170 /41171**

Please keep this page for your online registration.





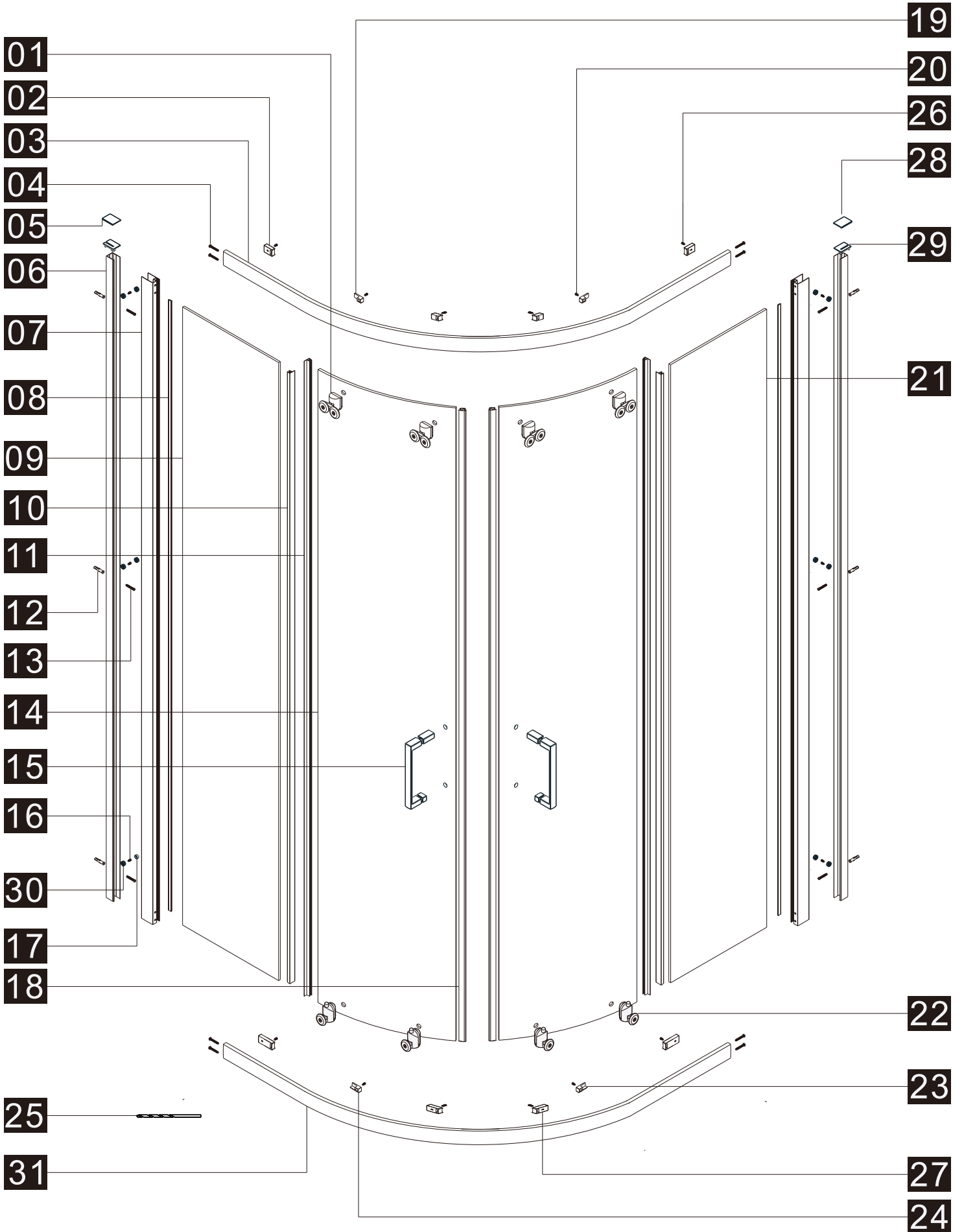













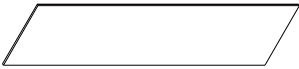

No. FIENSEB14V3.0





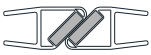

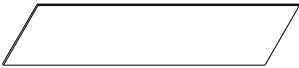





Attention: Before installation, please check whether the number and type of accessories are correct, and then install them. If there is any problem, please inform us as soon as possible. Thank you!

Parts List

Part Number	Image	Size(mm)	Quantity	Remark
01			4	
02			4	Short
03			1	Aluminum profile
04		ST3.5X30	8	
05			1	L Side
06		1850	2	Aluminum profile
07		1850	2	Aluminum profile
08		1786	2	Seal
09			1	L Side
10		1830	2	Seal
11		1770	2	Seal
12			6	
13		ST4X35	6	
14			2	
15			2	
16		ST4X10	6	
17			6	
18			1	Magnetic seal
19			2	
20		ST4X14	4	
21			1	R side
22			4	
23			1	L Side

Parts List

Part Number	Image	Size(mm)	Quantity	Remark
24			1	R side
25		∅2.8mm	1	
26		ST4X10	8	
27			4	Long
28			1	R side
29			2	
30			6	
31			1	Aluminum profile

You will need

To assemble your product (Tools not provided).

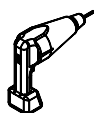

Drill



Drill Bit

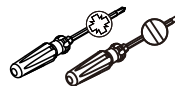

Screw Driver

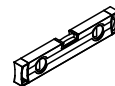

Level

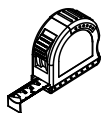

Tape Measure



Pencil



Mallet



Silicon Gun



Craft Knife

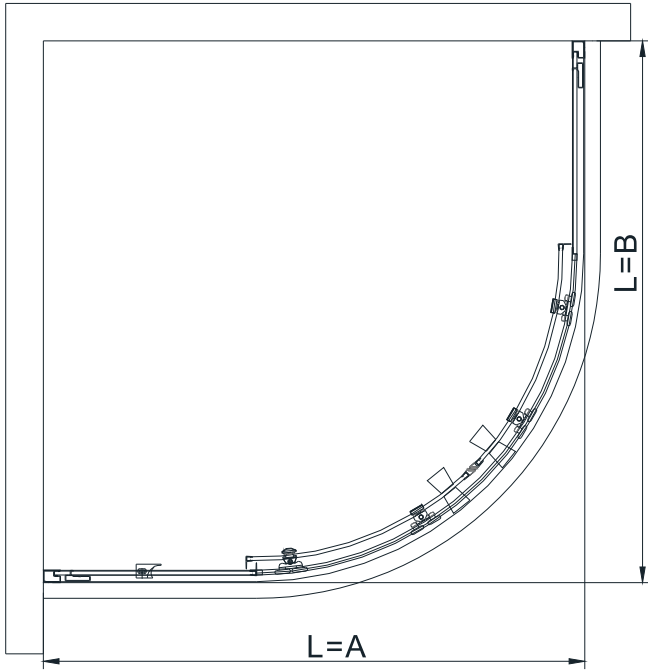

SIZE	A	B
41137/41120	765-780	765-780
41138/41121	865-880	865-880
41122	865-880	725-740
41123/41169	965-980	765-780
41124/41170	1165-1180	765-780
41125/41171	1165-1180	865-880

Note:
 In consideration of the influence of walls and tiles, the actual installation size will be smaller than the size declared on the website, but it will not affect the normal usage. The adjustment shall be subject to the manual instructions.

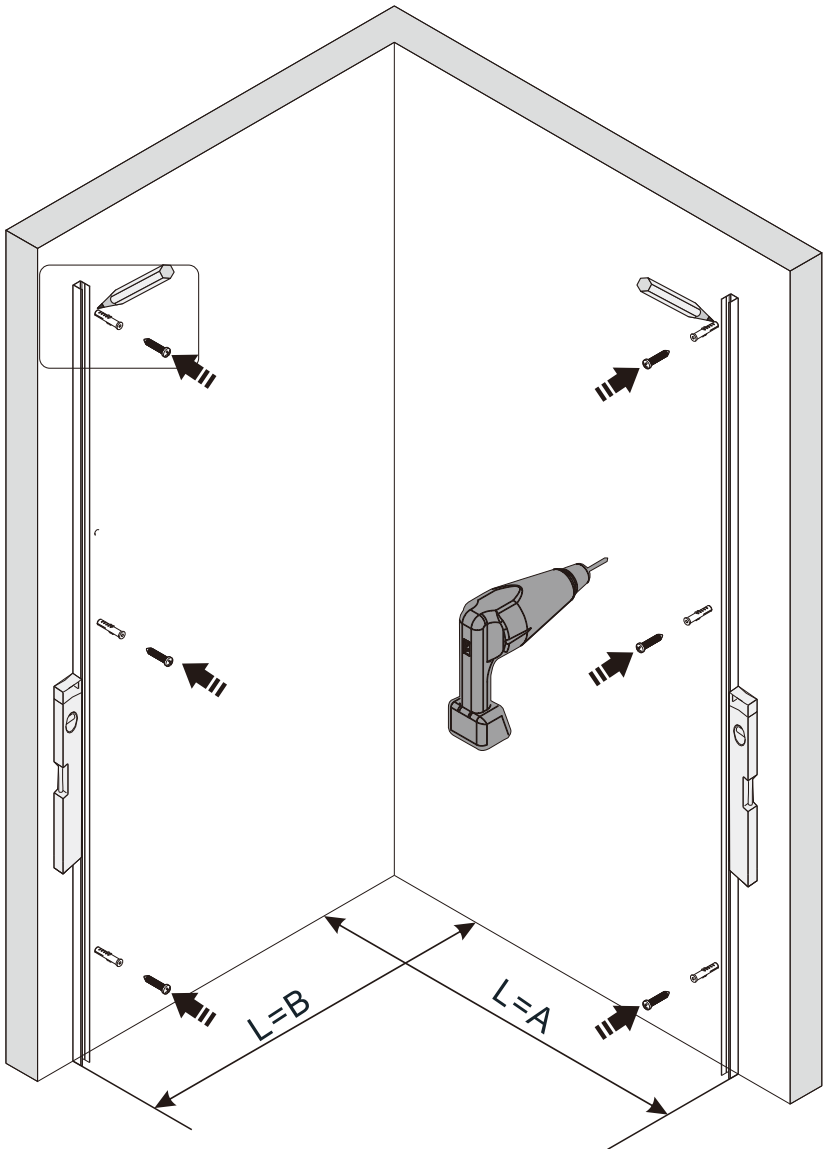
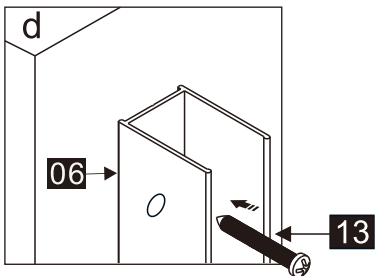
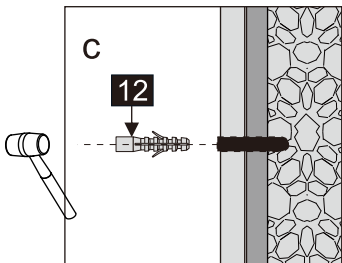
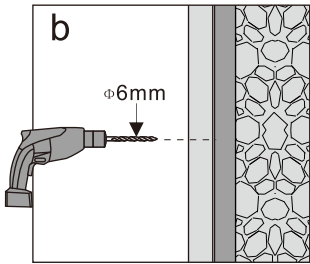
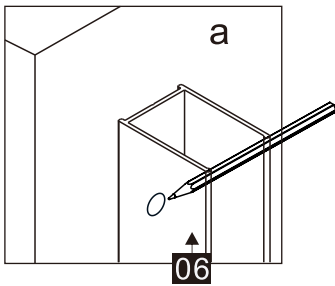

02

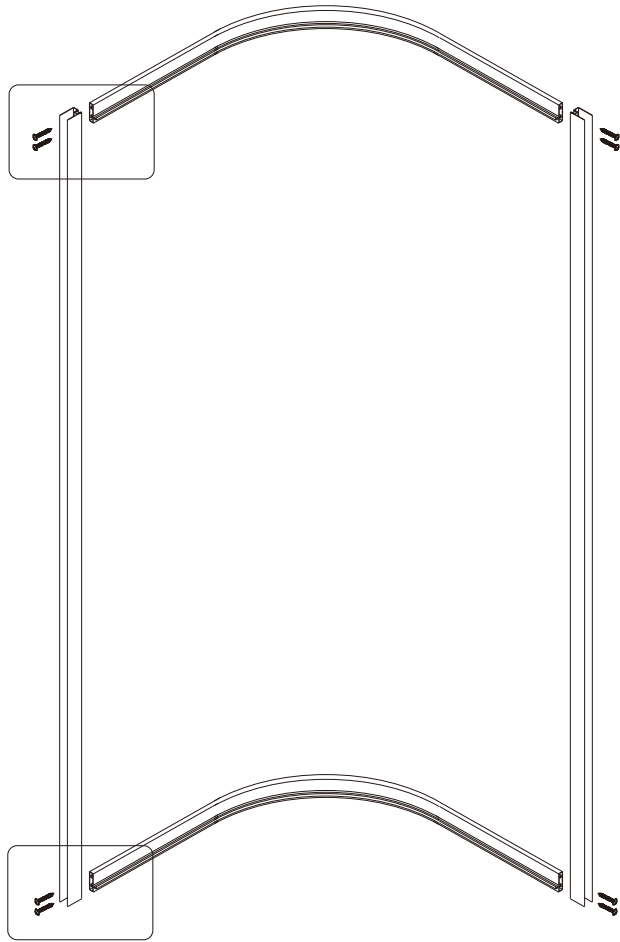
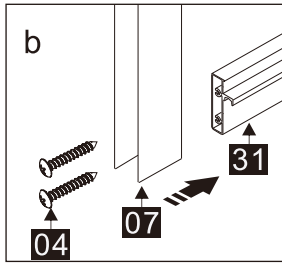
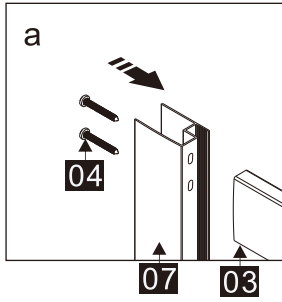

03

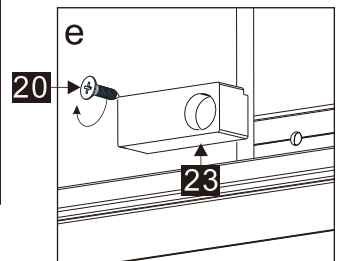
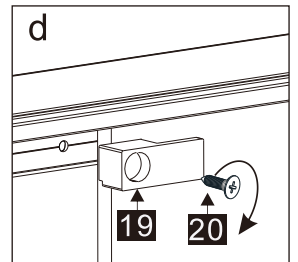
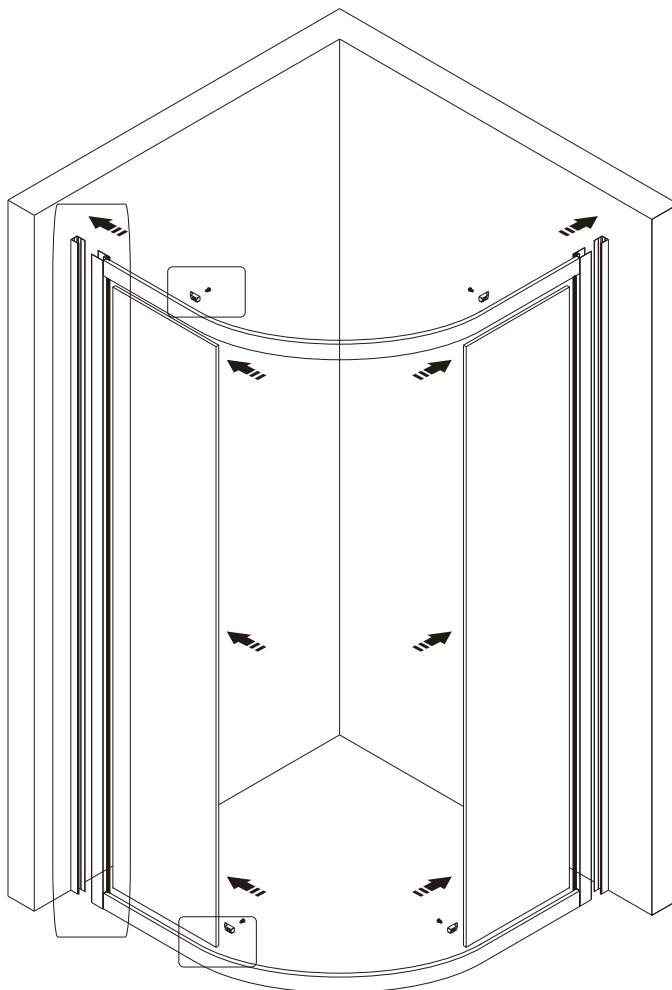
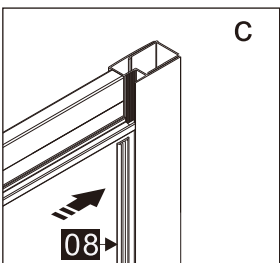
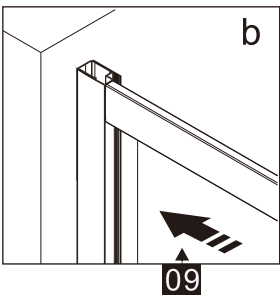
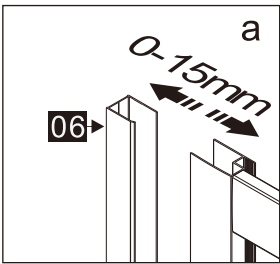

04

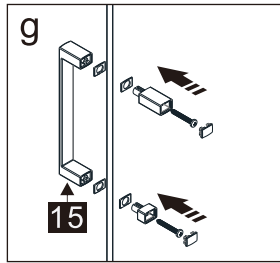
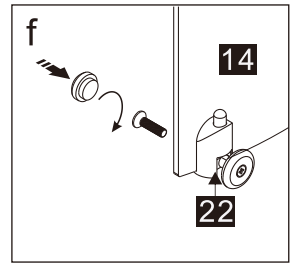
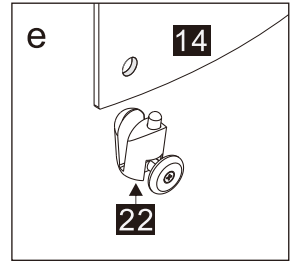
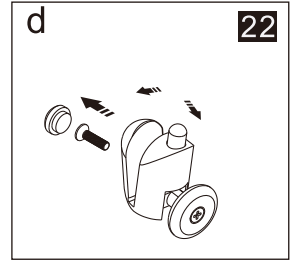
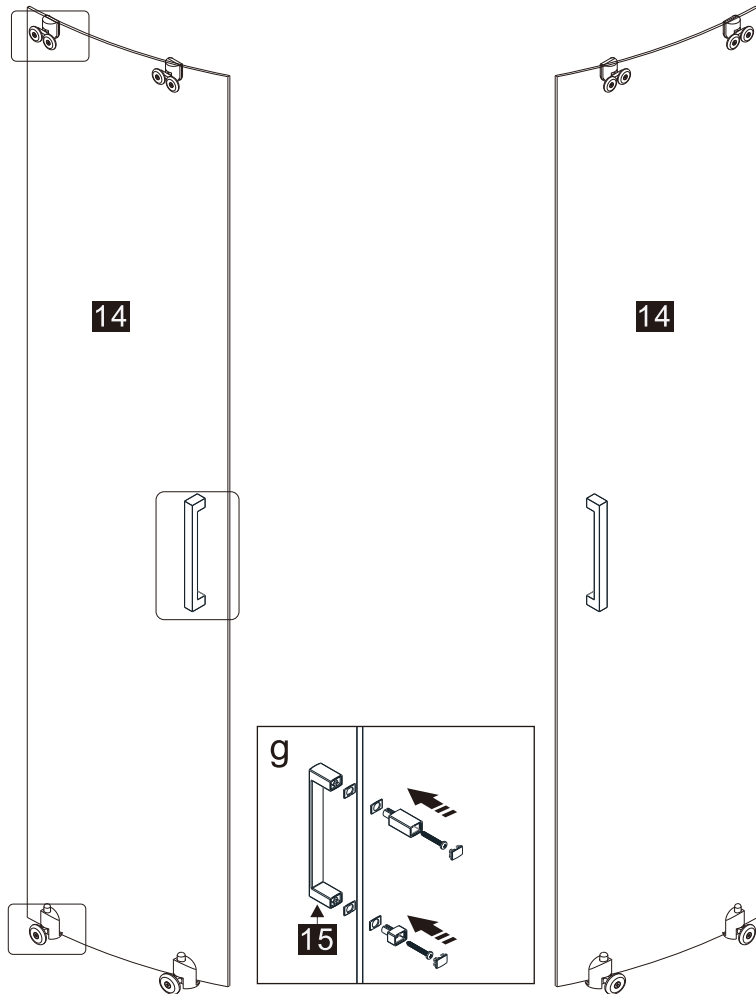
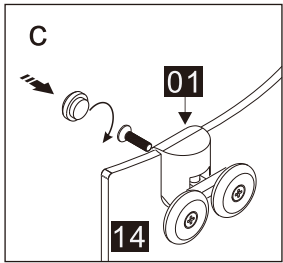
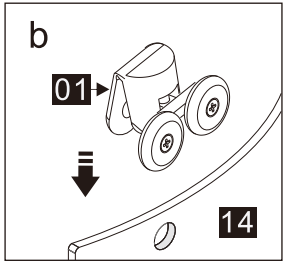
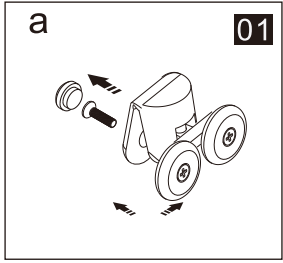

Caution:
 The handle is made of plastic
 1、 If an electric screwdriver is used, the torque shall not exceed 10 N;
 2、 If a manual screwdriver is used, do not over tighten;
 Otherwise the handle may be damaged.

05

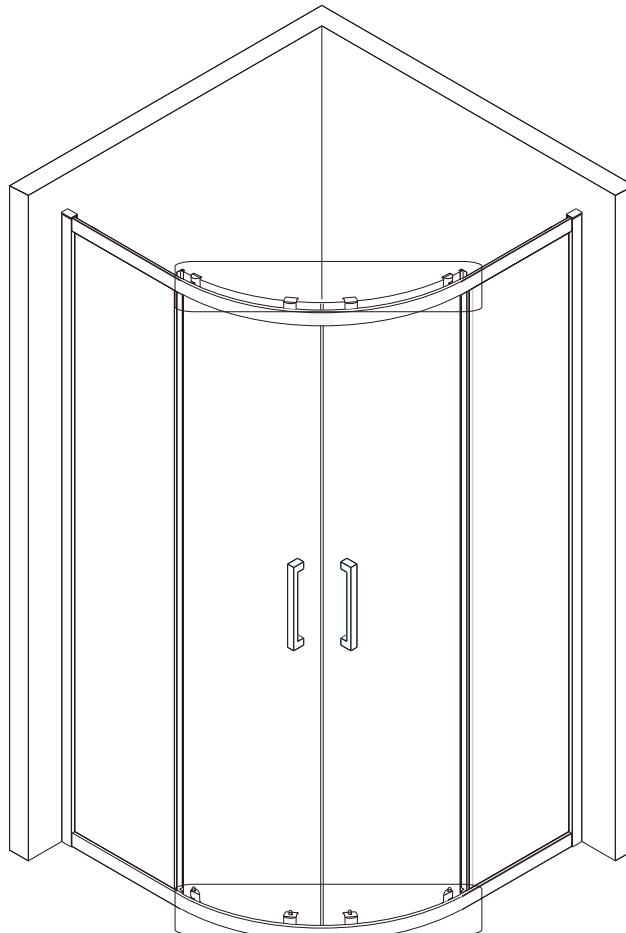
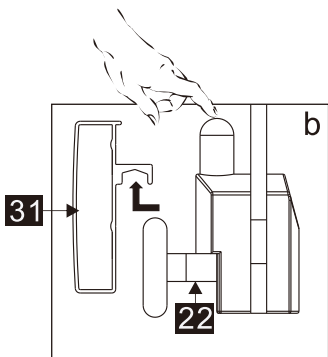
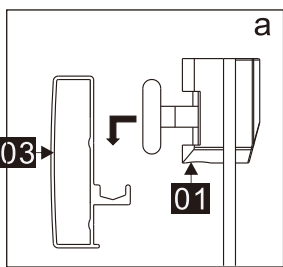

06

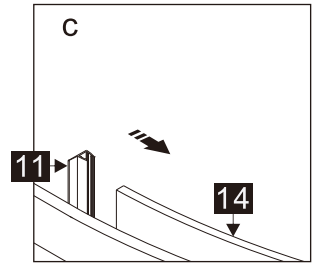
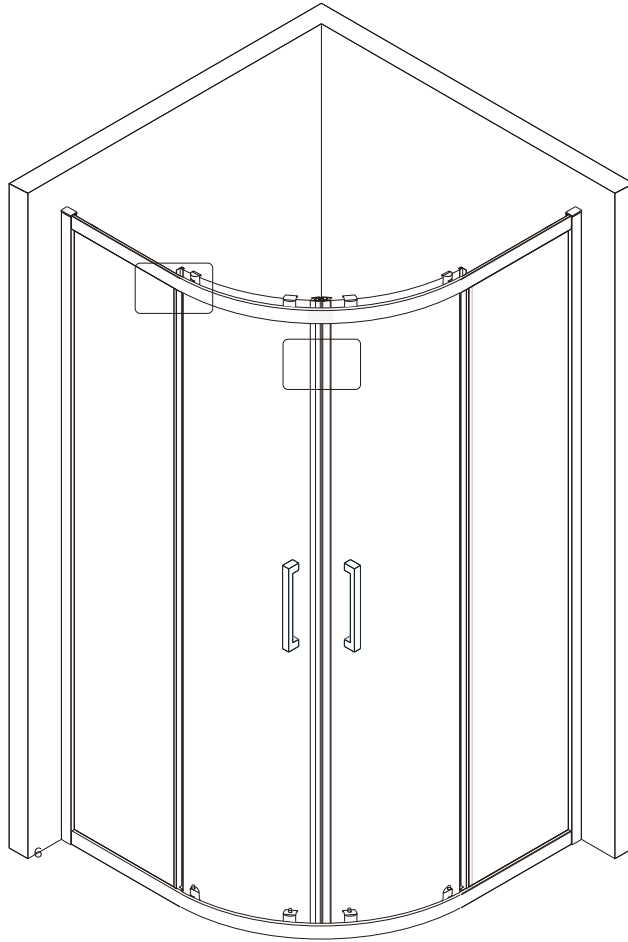
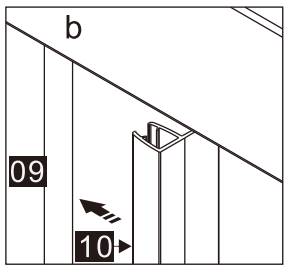
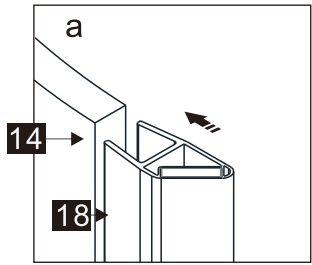

07

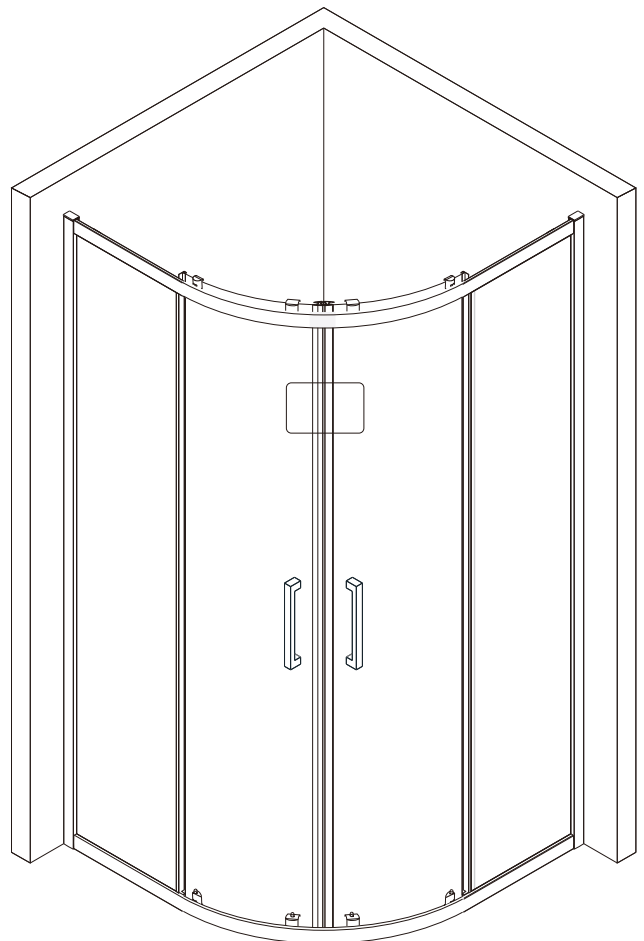
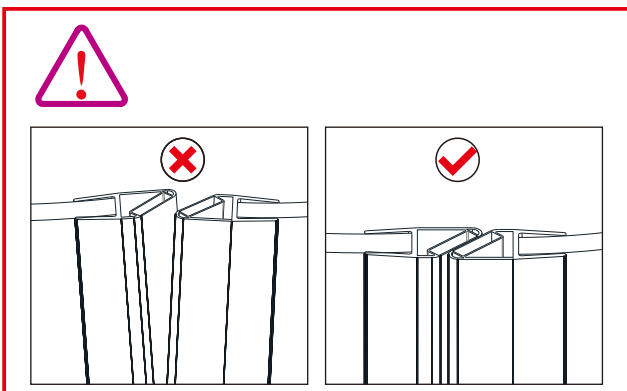
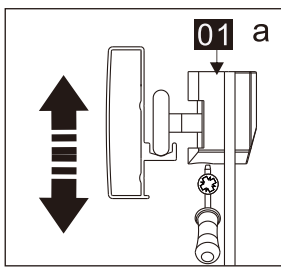

08

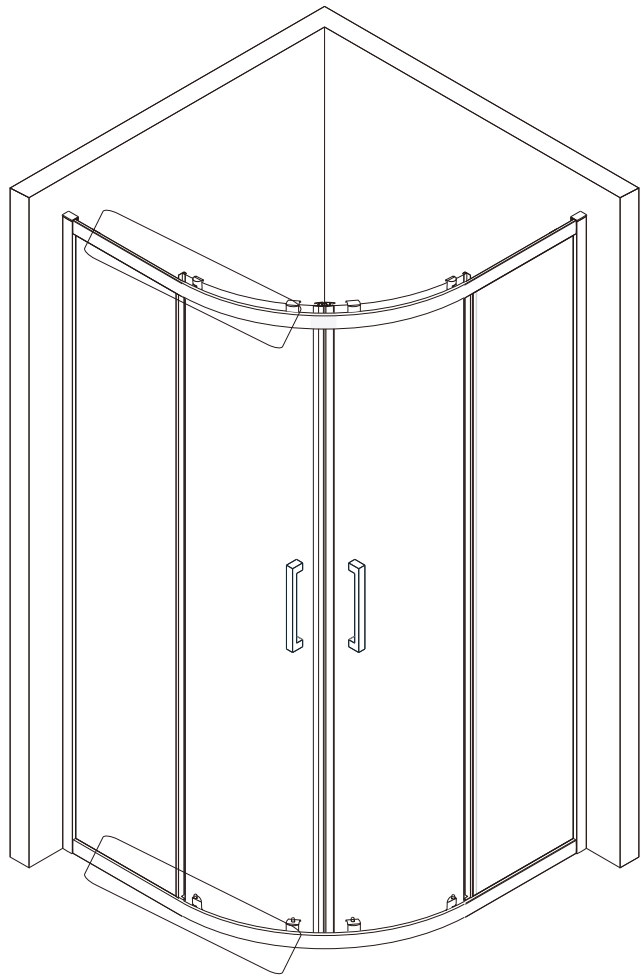
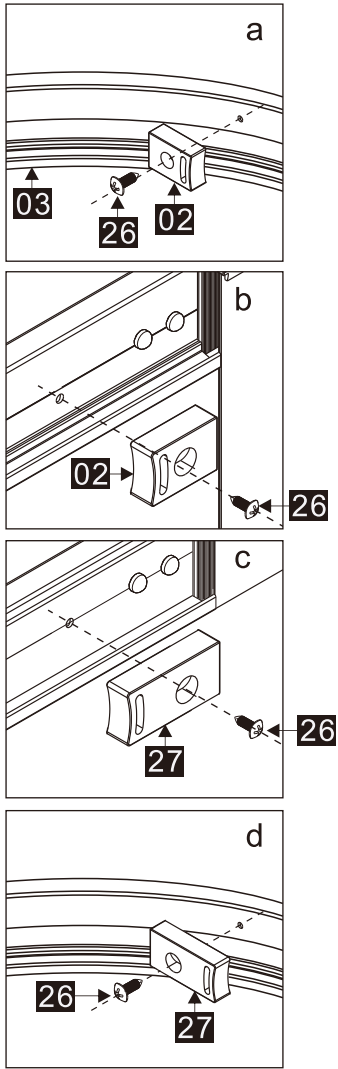

09

Drilling holes on the right to prevent the glass from being broken

Drilling holes on the left to prevent the glass from being too close to the edge of aluminum profile

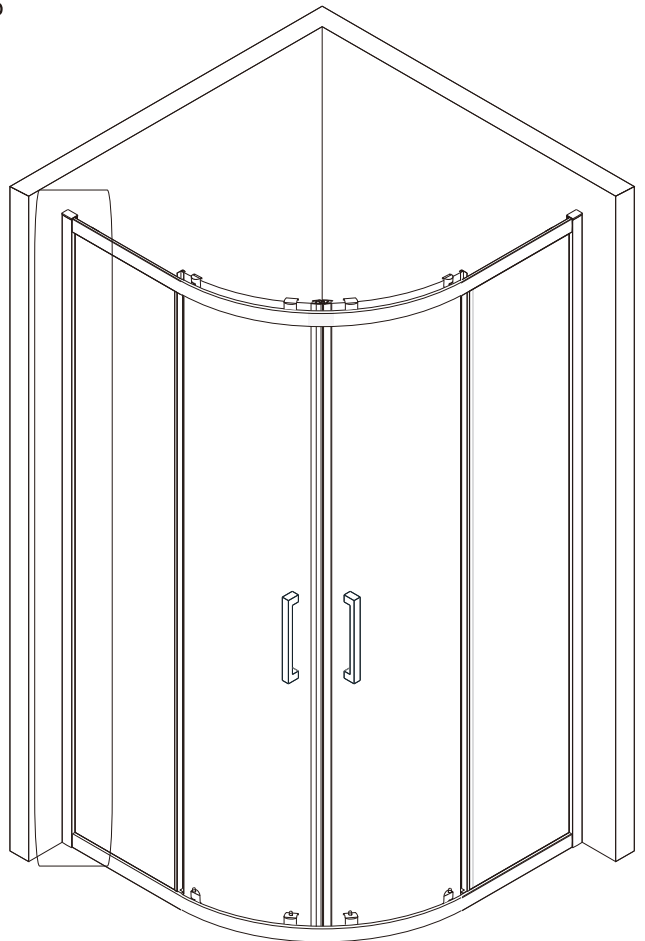
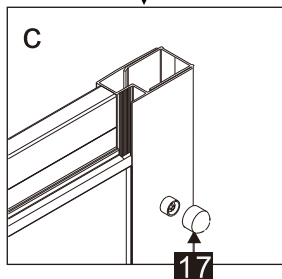
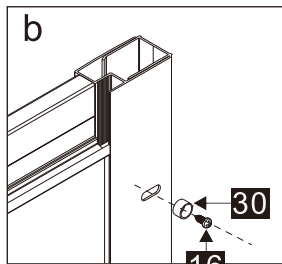
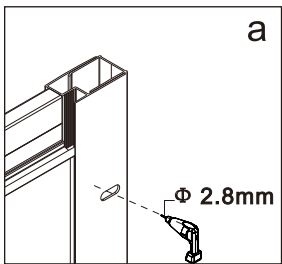
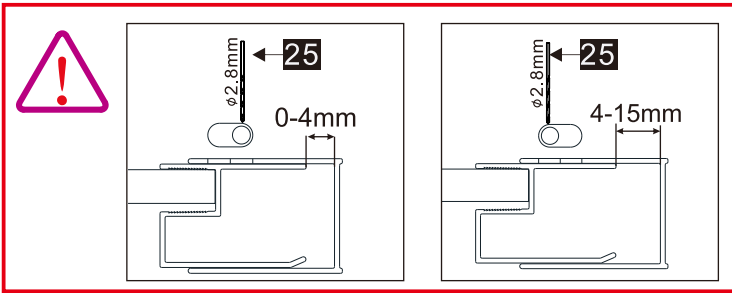

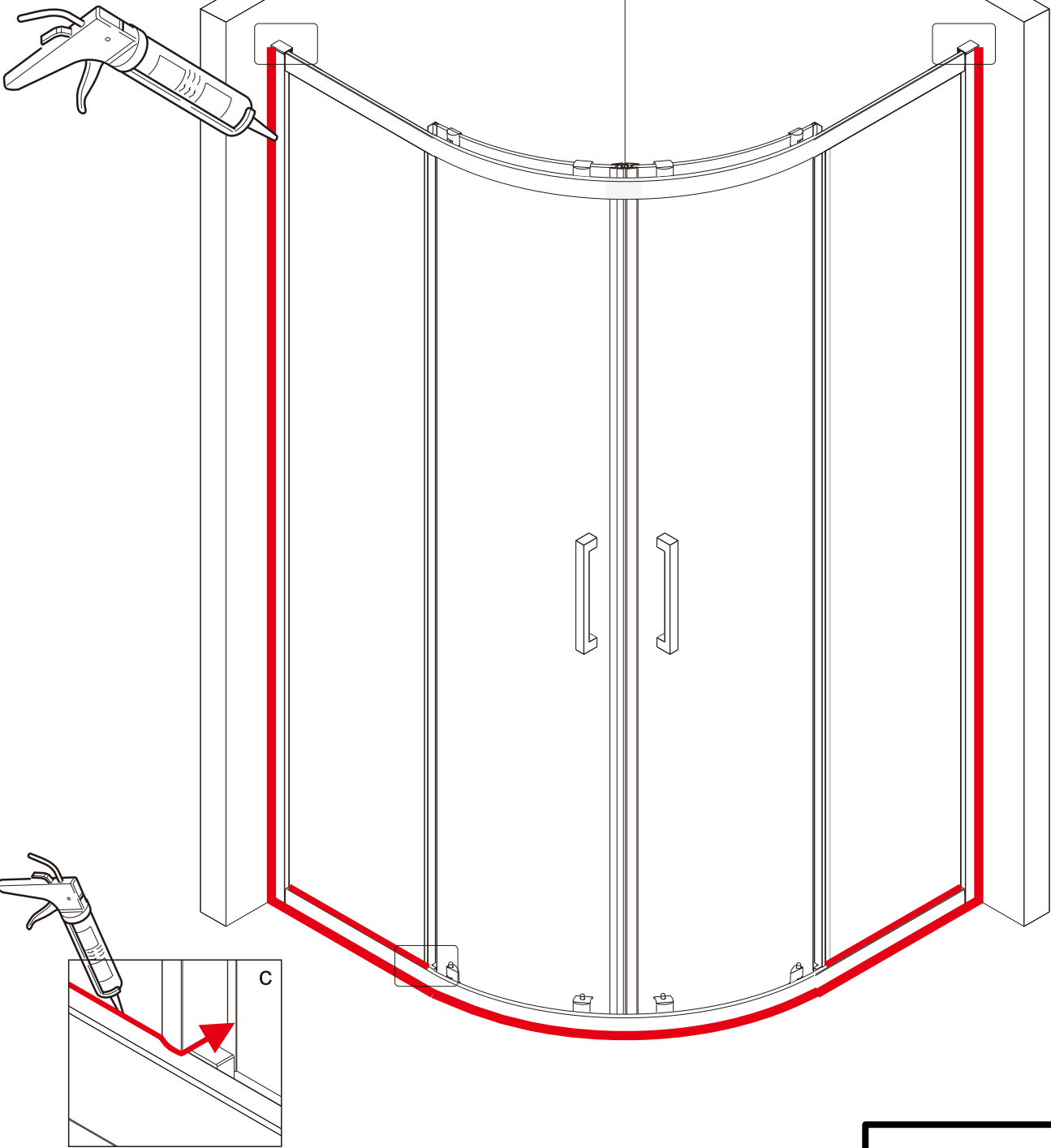
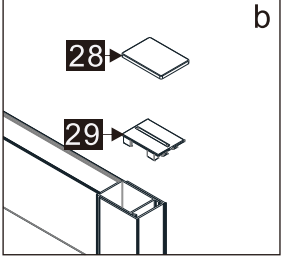
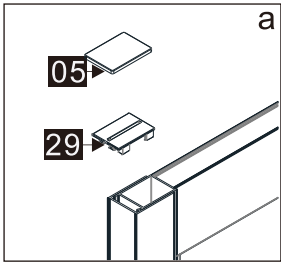

A rectangular box containing three warning icons: a clock icon with '24 h' below it, a crossed-out hand icon, and a crossed-out faucet icon.