

Installation Manual

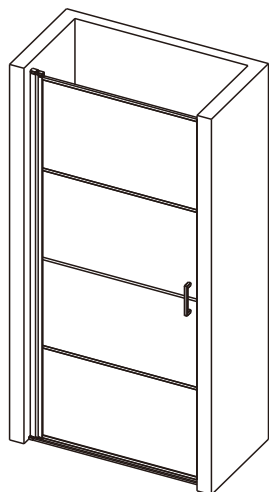

L

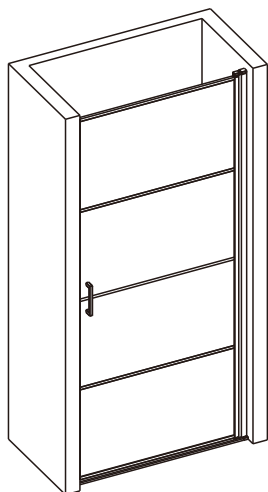

R

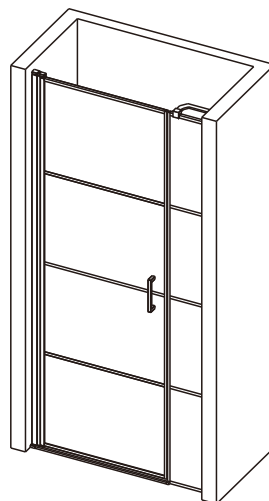

L

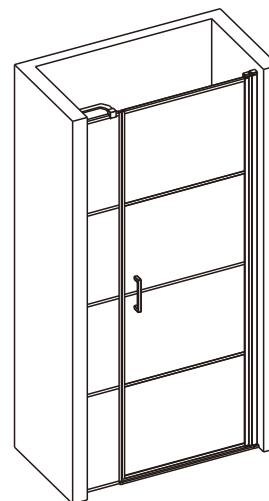

R

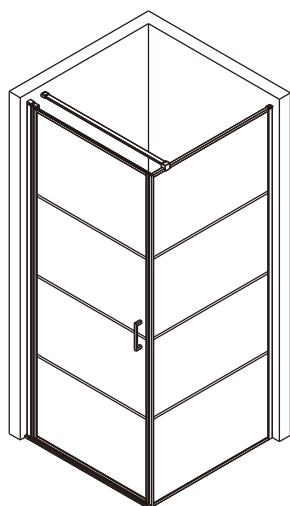

L

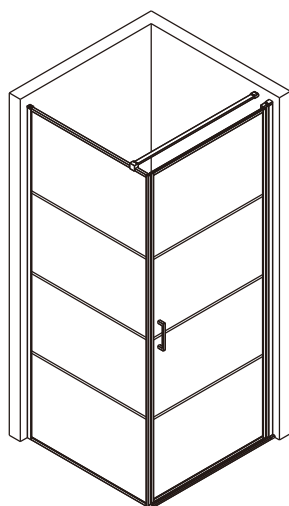

R

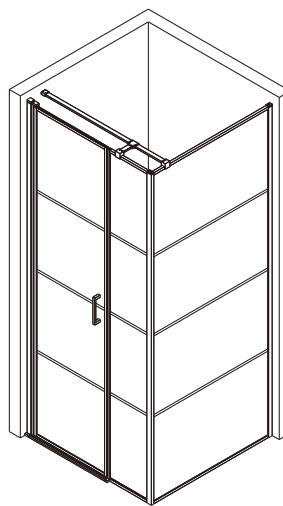

L

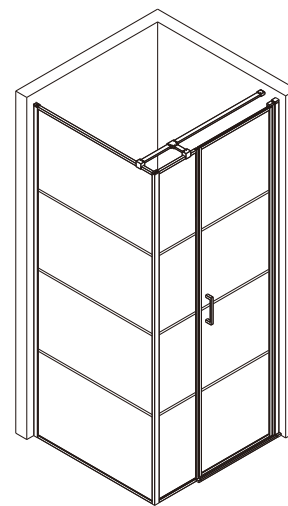

R

Apply for following models:

41190/41191/41192/41193
41194/43054/43055/43056
41206

Please keep this page for your online registration.

No. FIENSEB38V 8.0



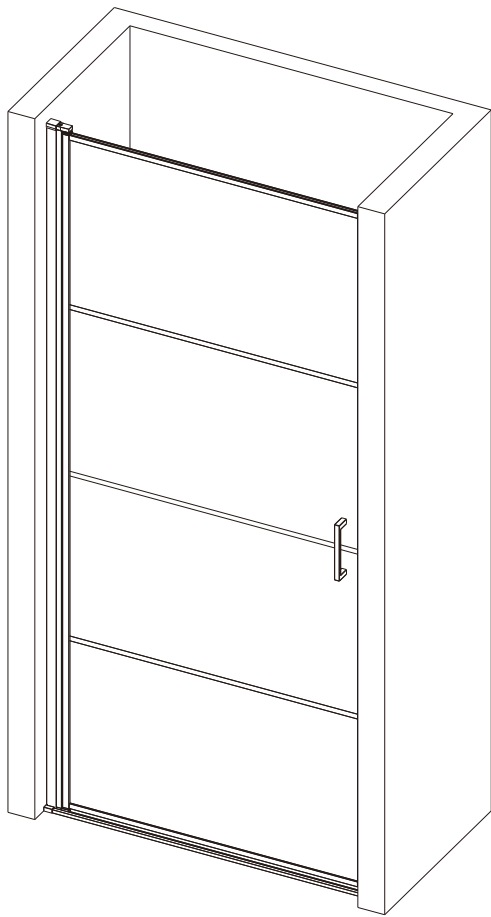

L

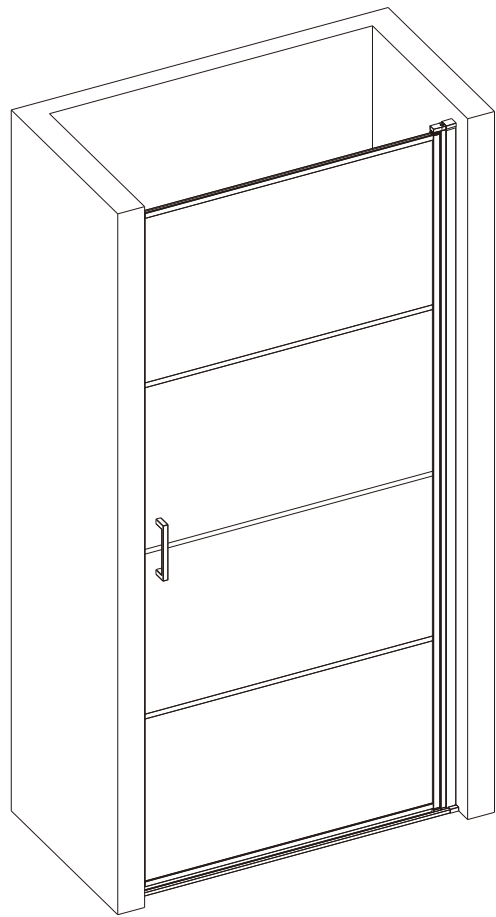

R

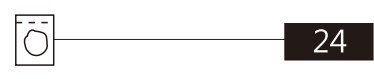
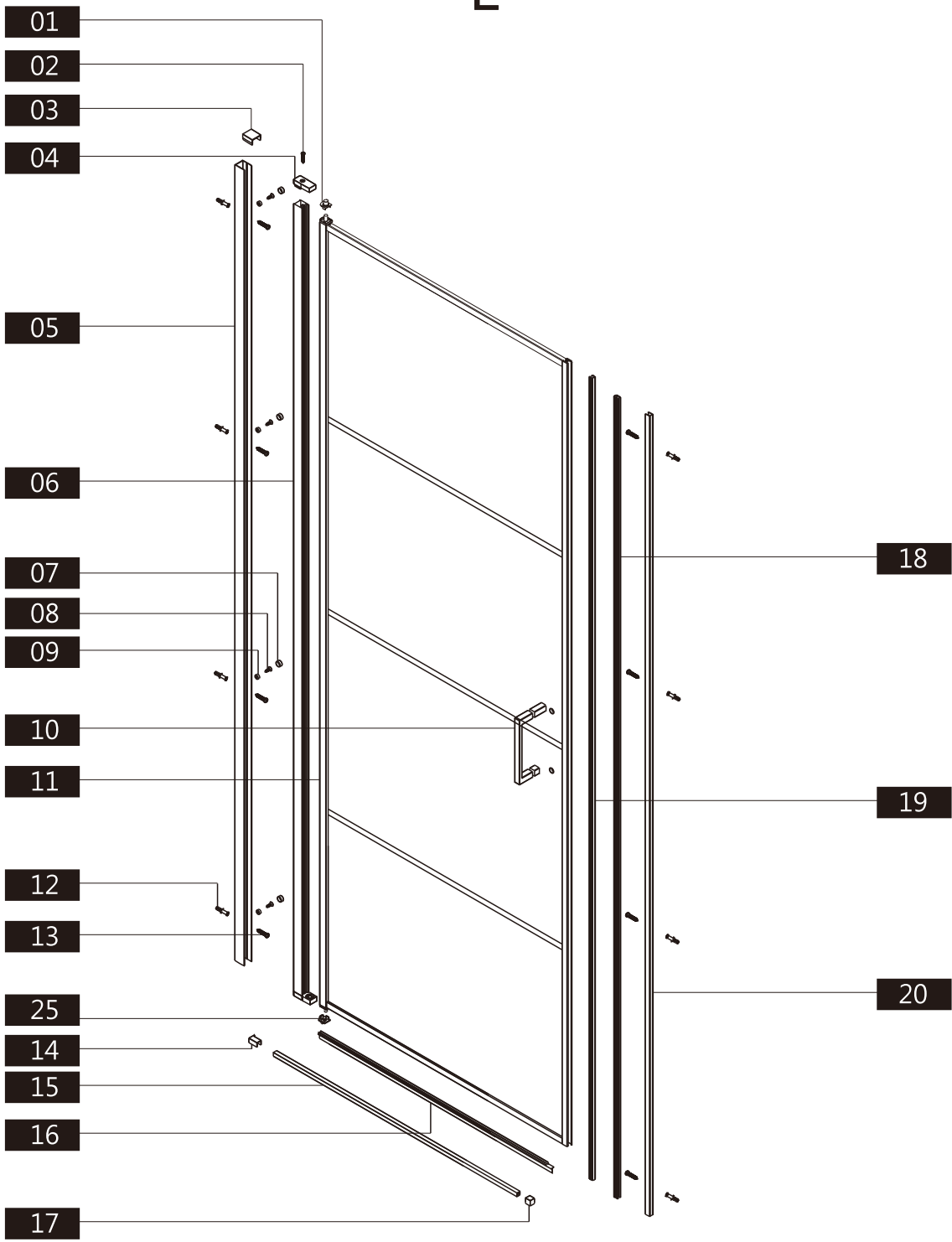

41190	700
41191	800
41192	900

L



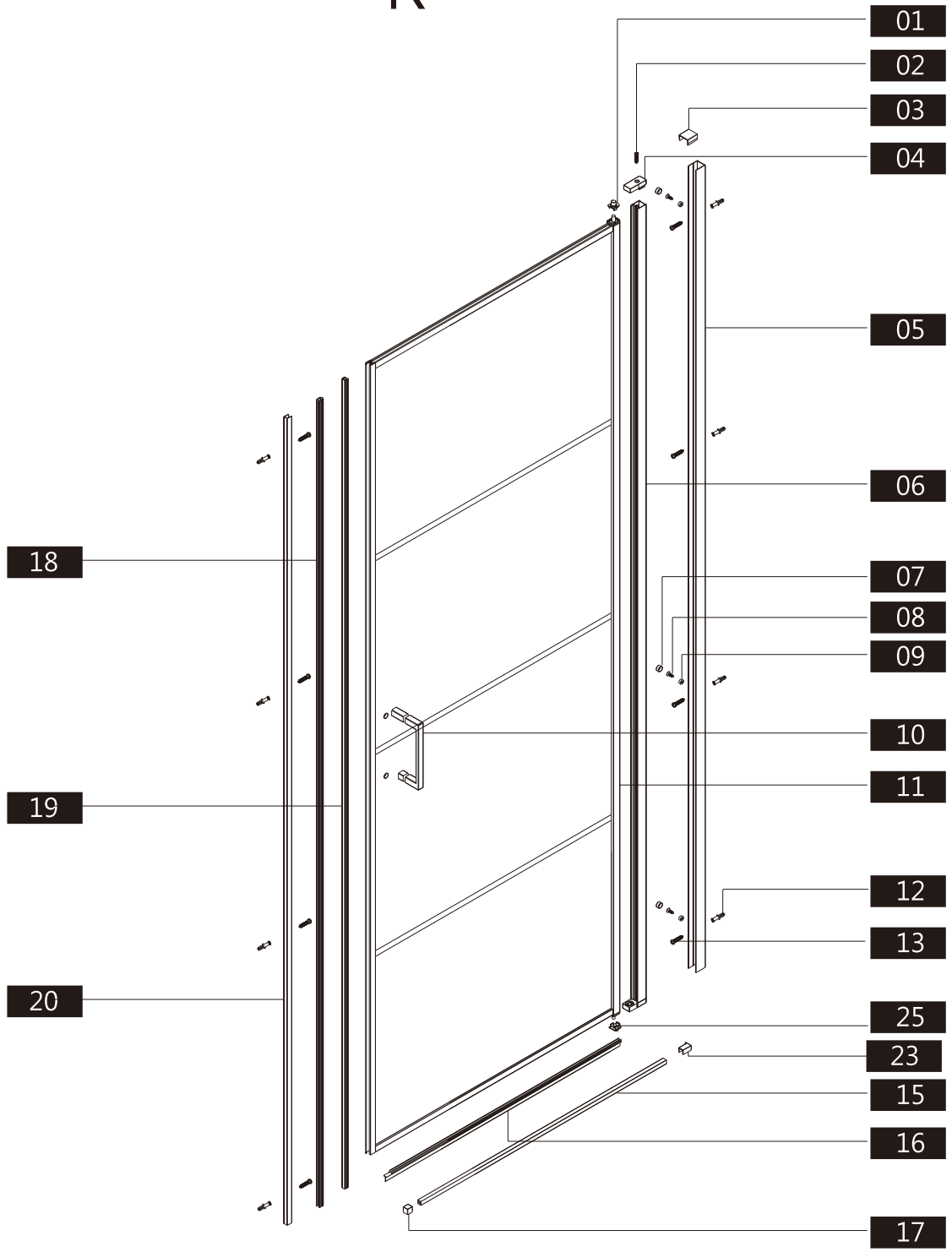



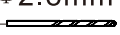











R



- 24 
- 26 
- 27  $\Phi 2.8\text{mm}$

Attention: Before installation, please check whether the number and type of accessories are correct, and then install them. If there is any problem, please inform us as soon as possible. Thank you!

Parts List

Part Number	Image	Size(mm)	Quantity	Remark
01			1	Top
02		ST3.5x35	1	
03			1	
04			1	Top
05		1970	1	Aluminum profile
06		1948	1	Aluminum profile
07			4	
08		ST4.0x10	4	
09			4	
10			1	
11			1	
12			8	
13		ST4.0x30	8	
14			1	L Side
15			1	Aluminum profile
16		625	1	Seal
17			1	
18		1950	1	Seal
19		1935	1	Seal
20		1950	1	Aluminum profile
21			1	L Side
22			1	R Side
23			1	R Side
24			1	
25			1	Bottom
26			1	
27		Φ2.8mm	1	

43055

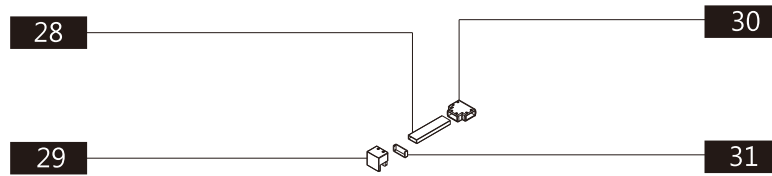

Parts List

Part Number	Image	Size(mm)	Quantity	Remark
28		100	1	Aluminum profile
29			1	
30			1	
31			1	

43056

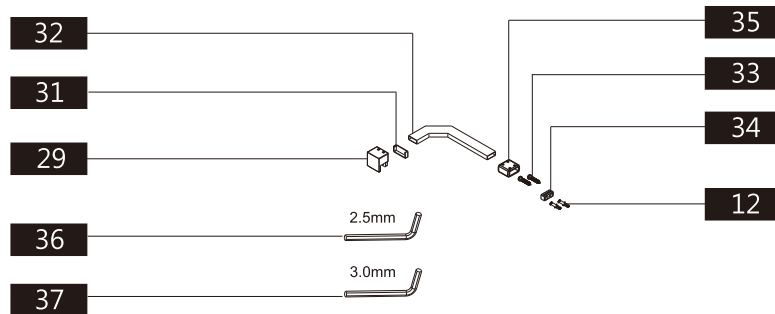





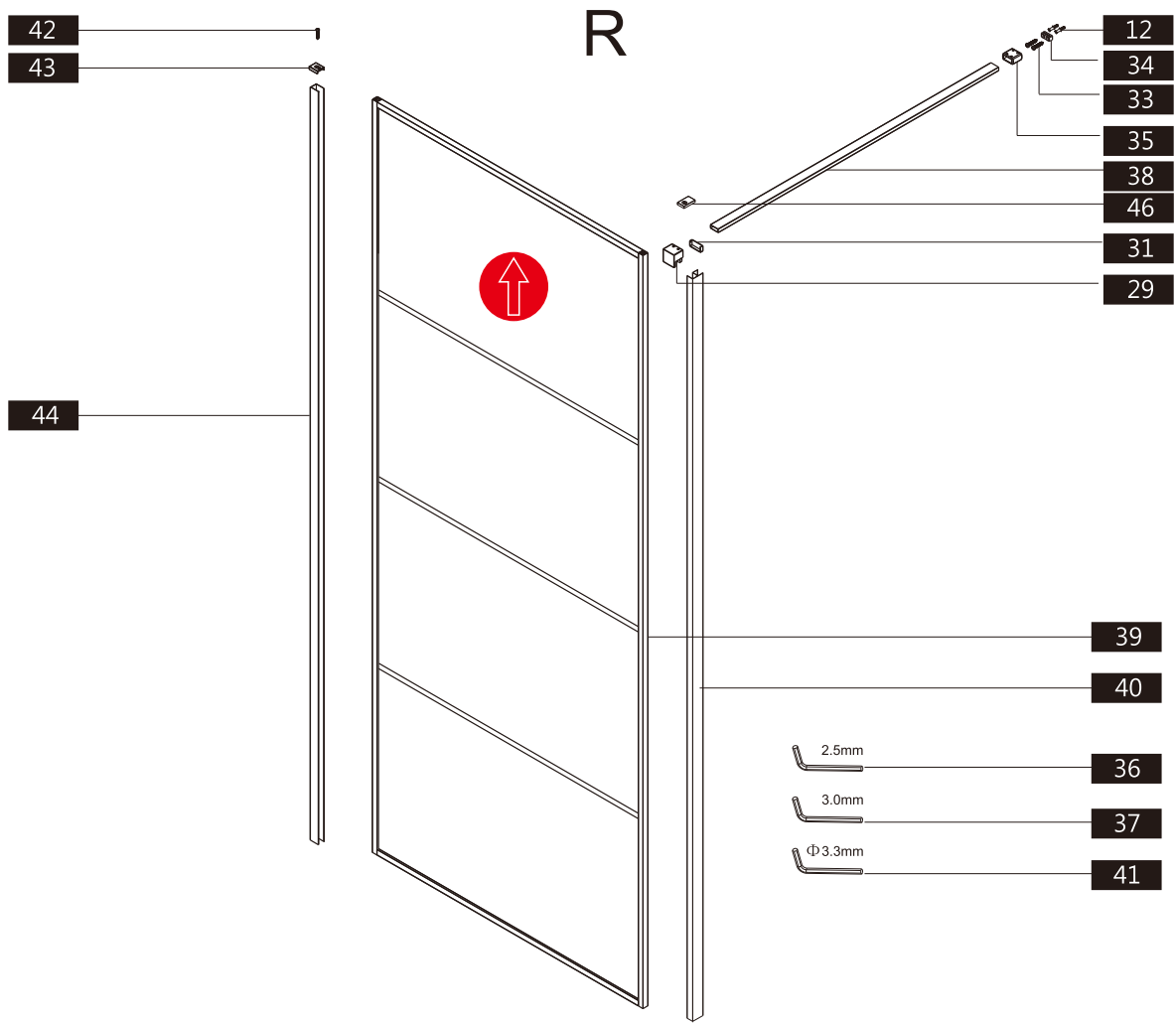
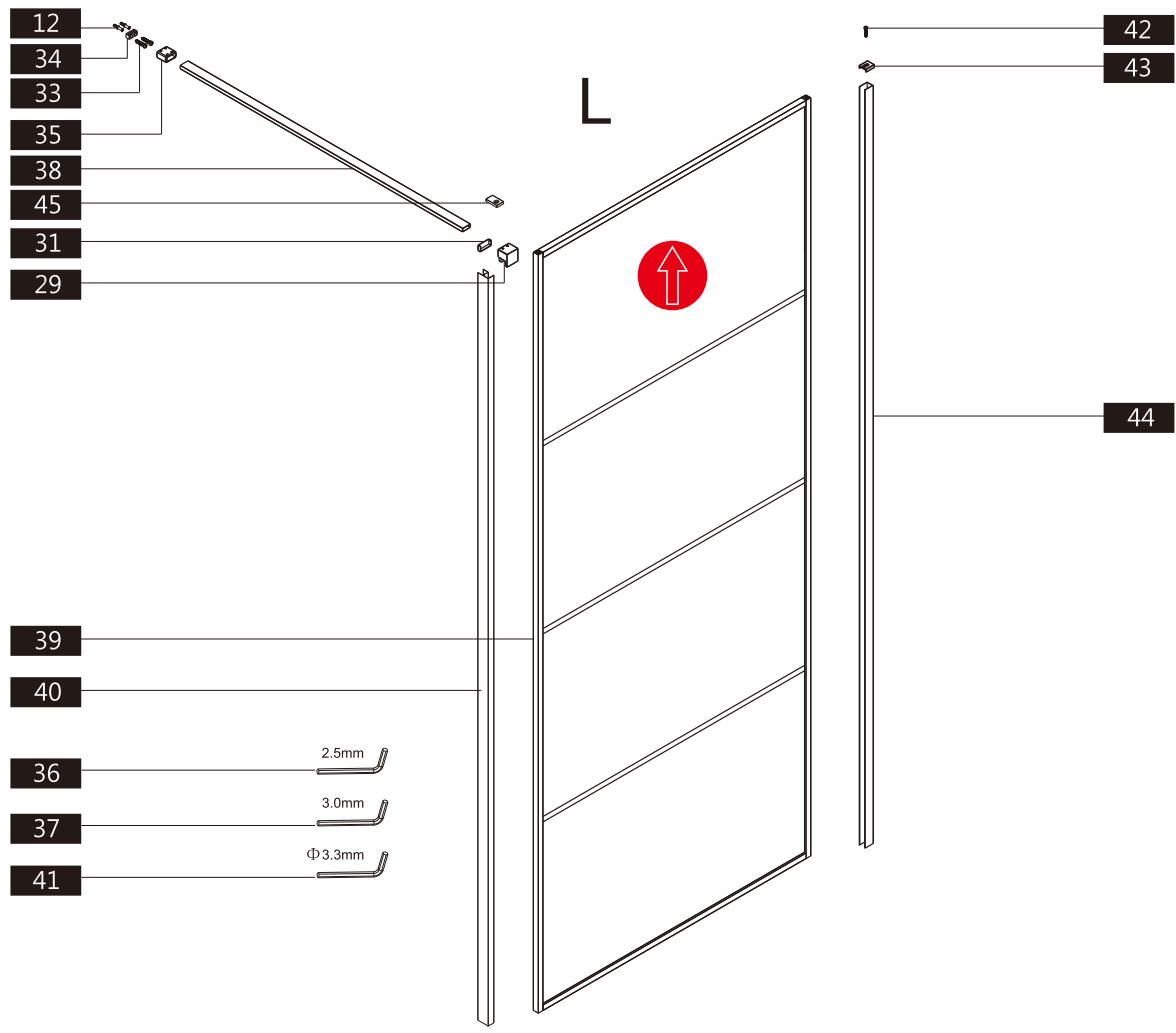











Parts List

Part Number	Image	Size(mm)	Quantity	Remark
12			2	
29			1	
31			1	
32			1	
33		ST4.0x30	2	
34			1	
35				
36		2.5mm	1	
37		3.0mm	1	



Parts List

Part Number	Image	Size(mm)	Quantity	Remark
12			2	
29			1	
31			1	
33		ST4.0x30	2	
34			1	
35				
36		2.5mm	1	
37		3.0mm	1	
38		1165	1	Aluminum profile
39			1	
40		1950	1	Aluminum profile
41		Φ3.3mm	1	
42		ST3.5x19	1	
43			1	
44		1950	1	Aluminum profile
45			1	L Side
46			1	R Side

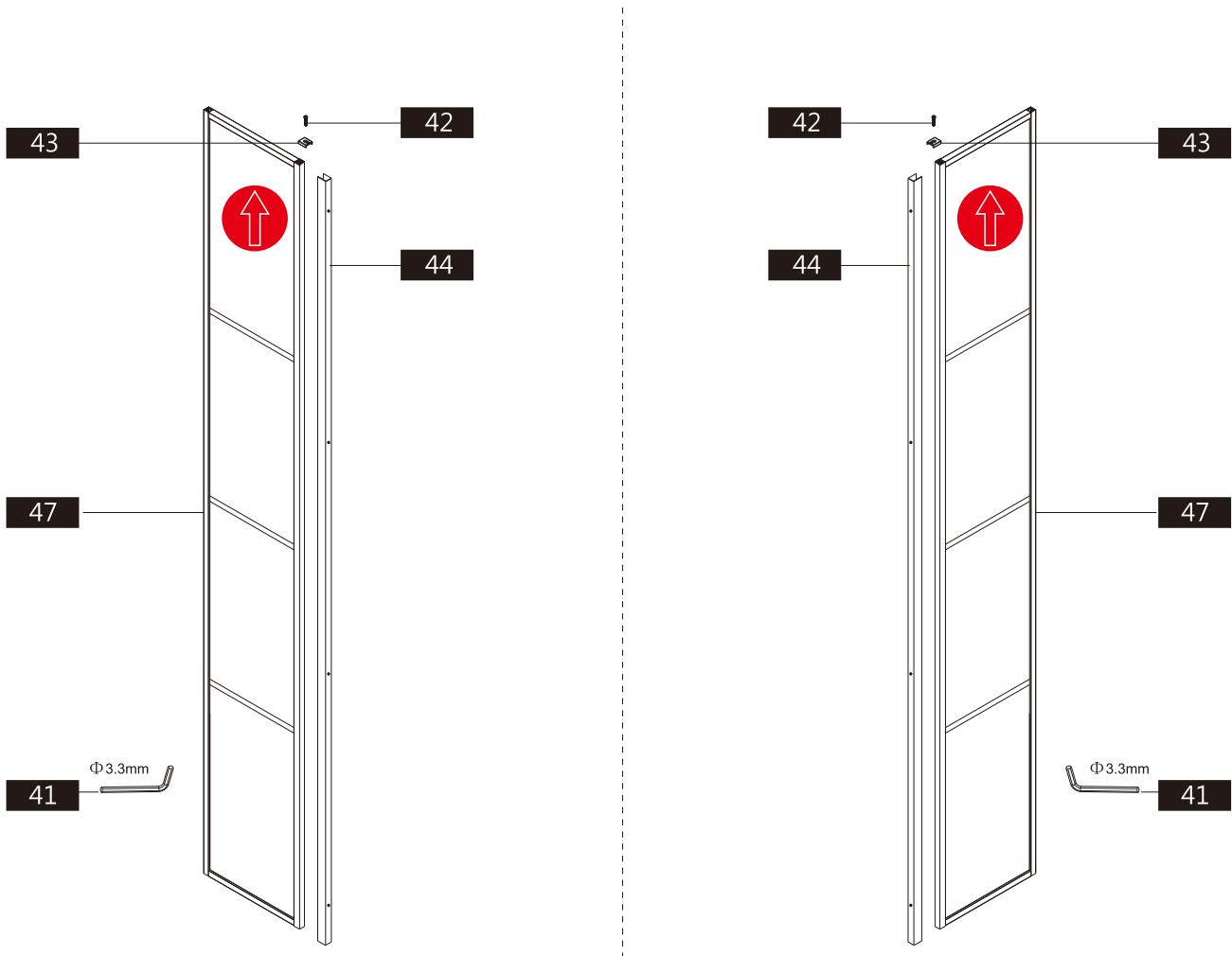

Parts List

Part Number	Image	Size(mm)	Quantity	Remark
41		Φ3.3mm	1	
42		ST3. 5x19	1	
43			1	
44		1950	1	Aluminum profile
47			1	

You will need

To assemble your product (Tools not provided).

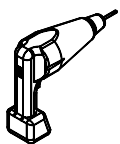

Drill



Drill Bit

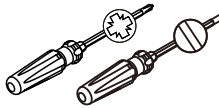

Screw Driver

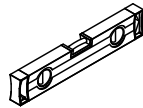

Level

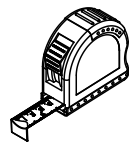

Tape Measure



Pencil



Mallet



Silicone Gun



Craft Knife

01

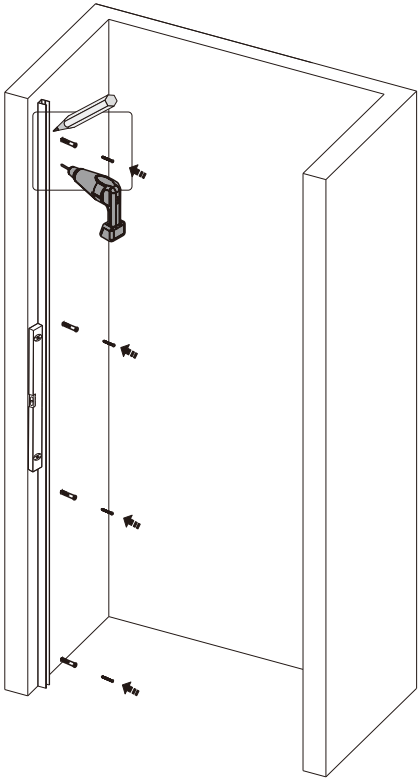

SIZE(mm)	A
41190	675~690
41191	775~790
41192	875~890

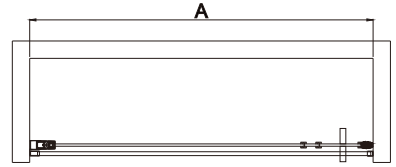

Note:
In consideration of the influence of walls and tiles, the actual installation size will be smaller than the size declared on the website, but it will not affect the normal usage. The adjustment shall be subject to the manual instructions.

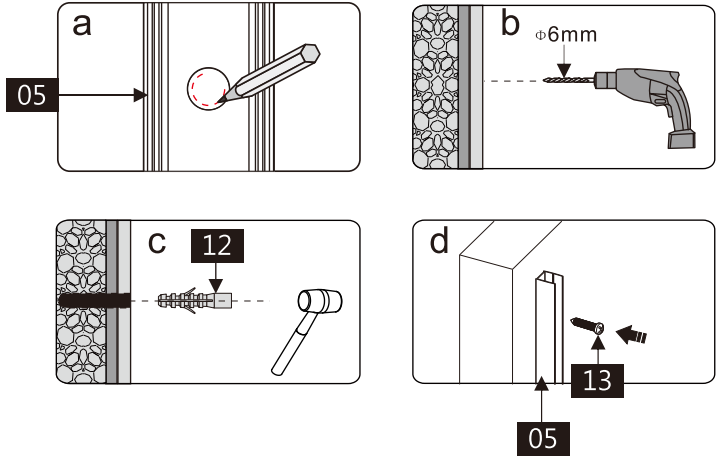

02

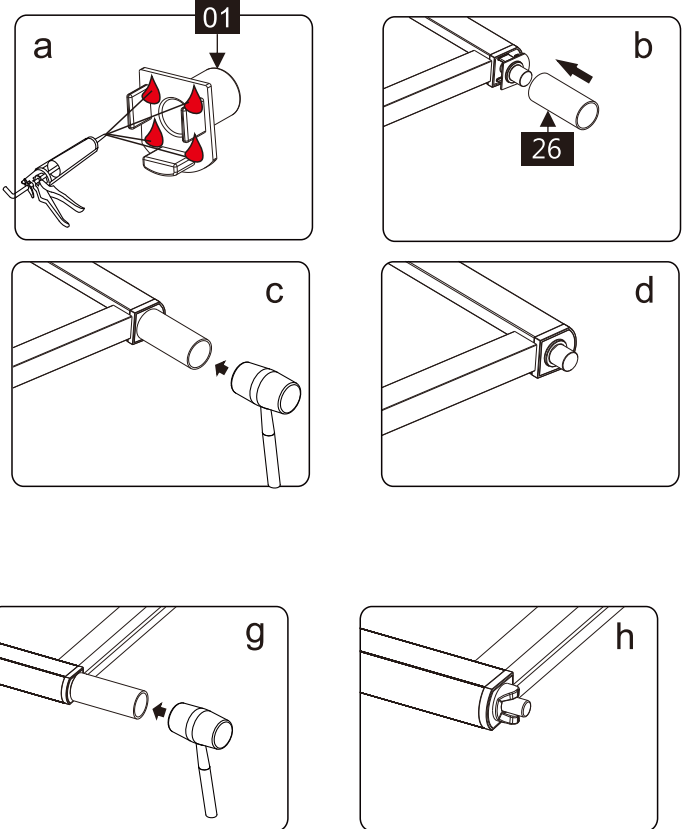
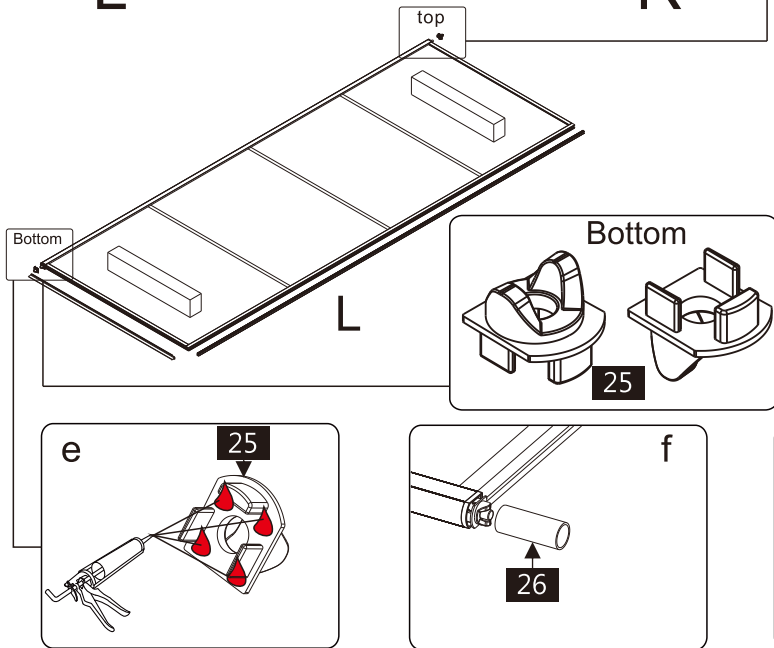
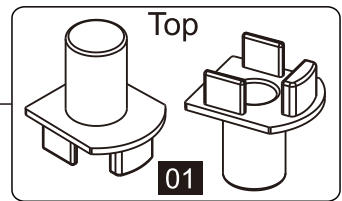
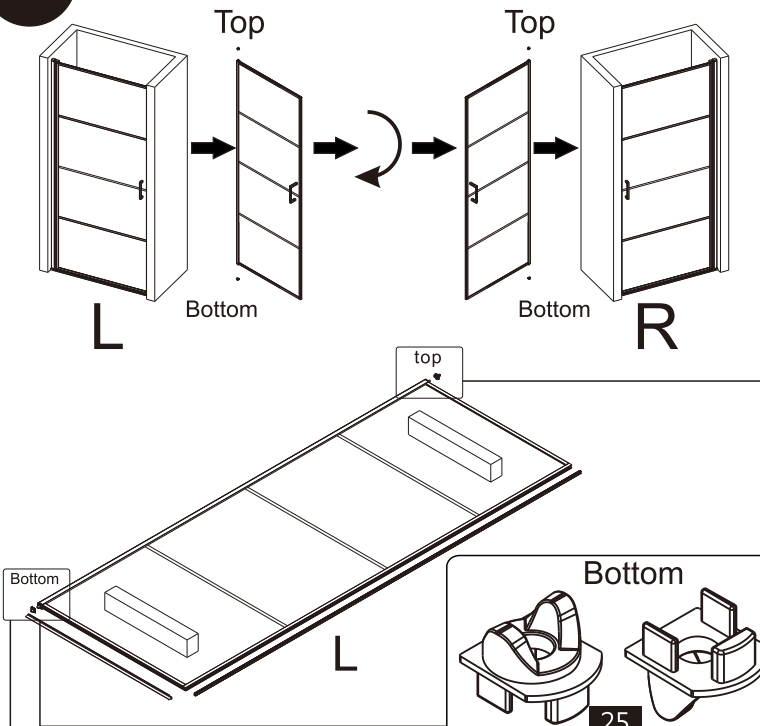

03

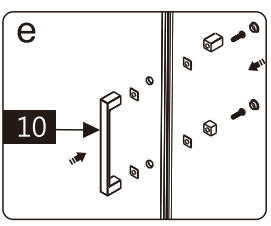
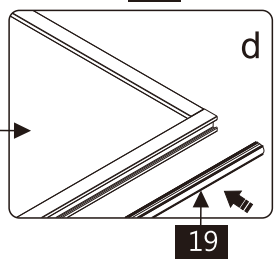
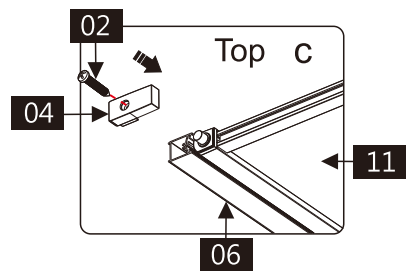
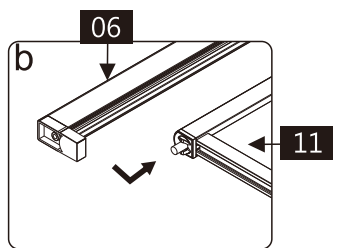
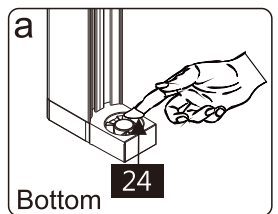
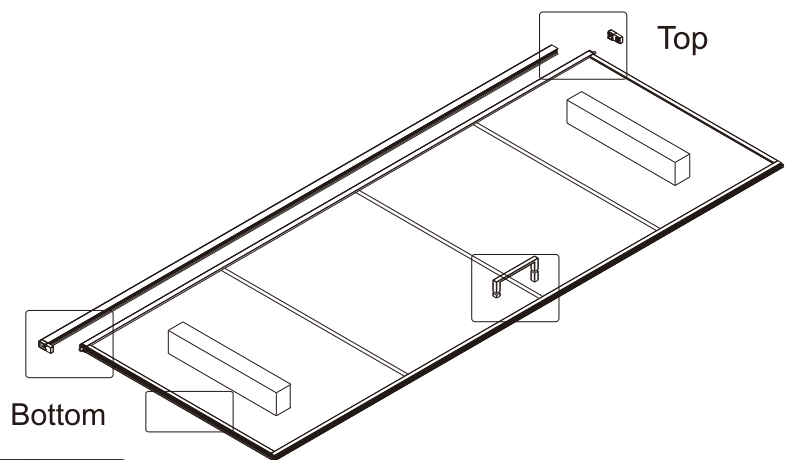

Caution:
 The handle is made of plastic
 1. If an electric screwdriver is used, the torque shall not exceed 10 N;
 2. If a manual screwdriver is used, do not over tighten;
 Otherwise the handle may be damaged.

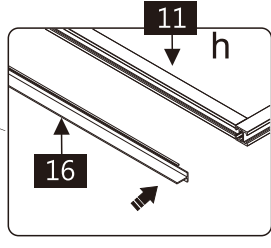
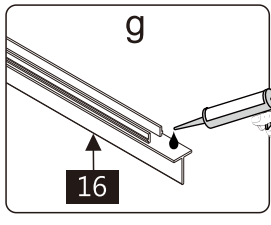
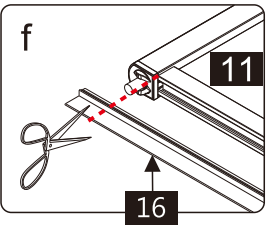

04

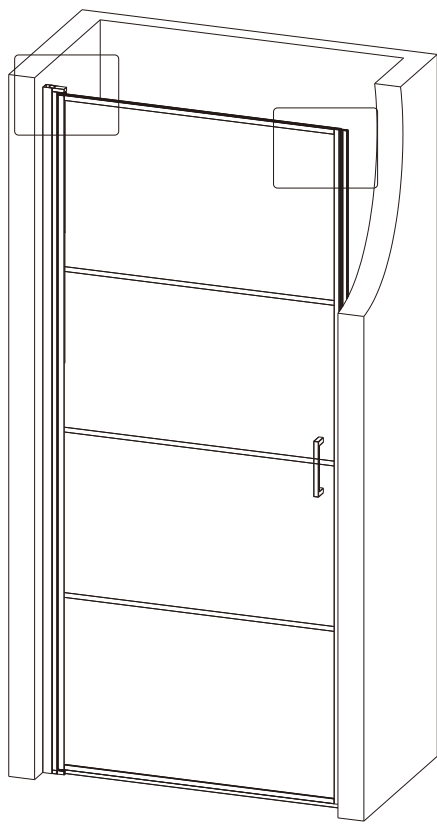

The black strip printing should be outside.

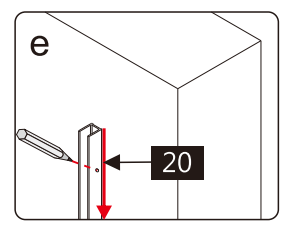
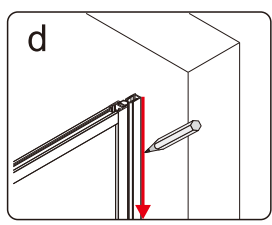
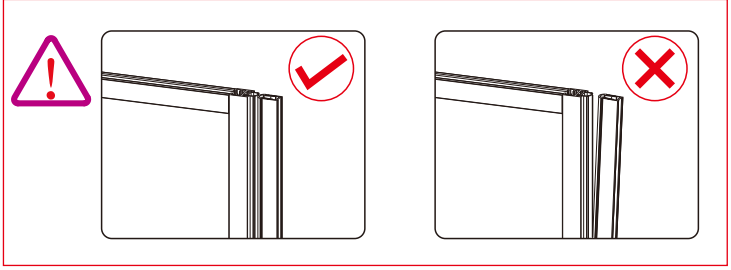
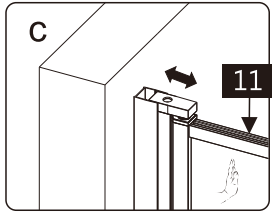
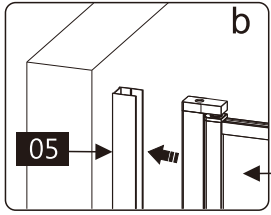
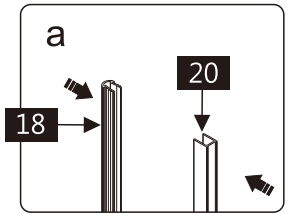
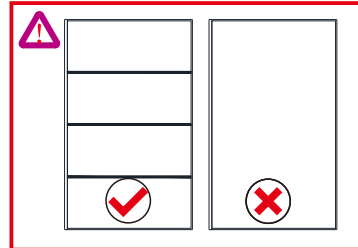

Attention: In order to prevent the bending of aluminum, the side screws 08 should be locked in the middle first and then at both ends.

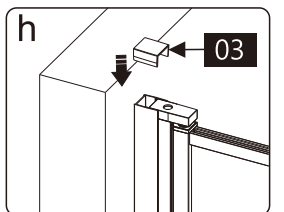
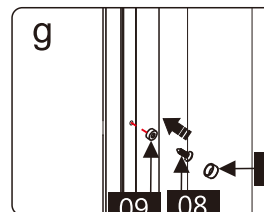
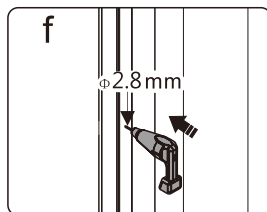
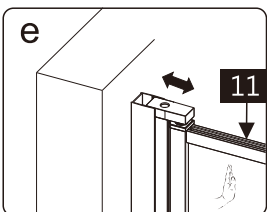
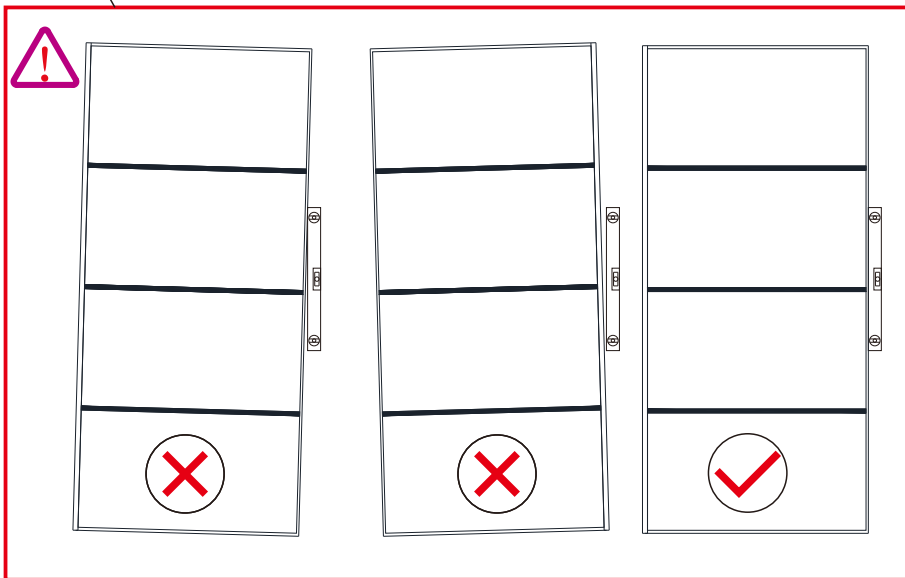
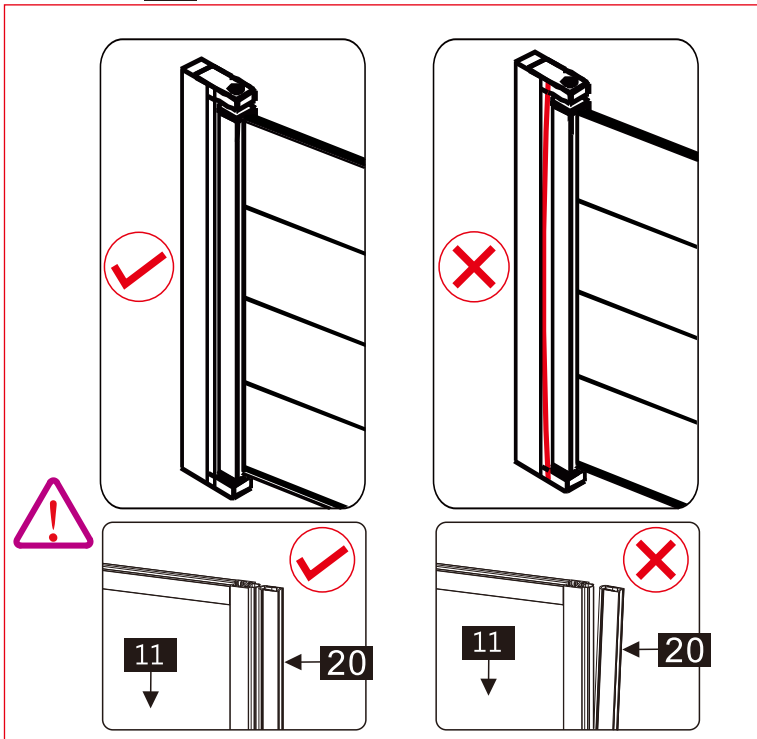
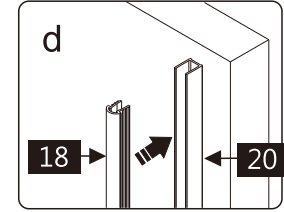
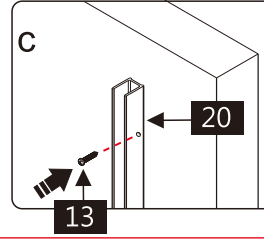
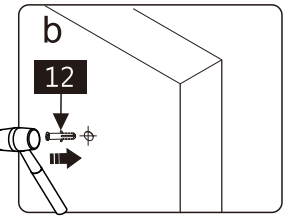
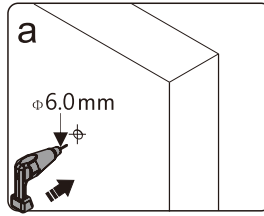
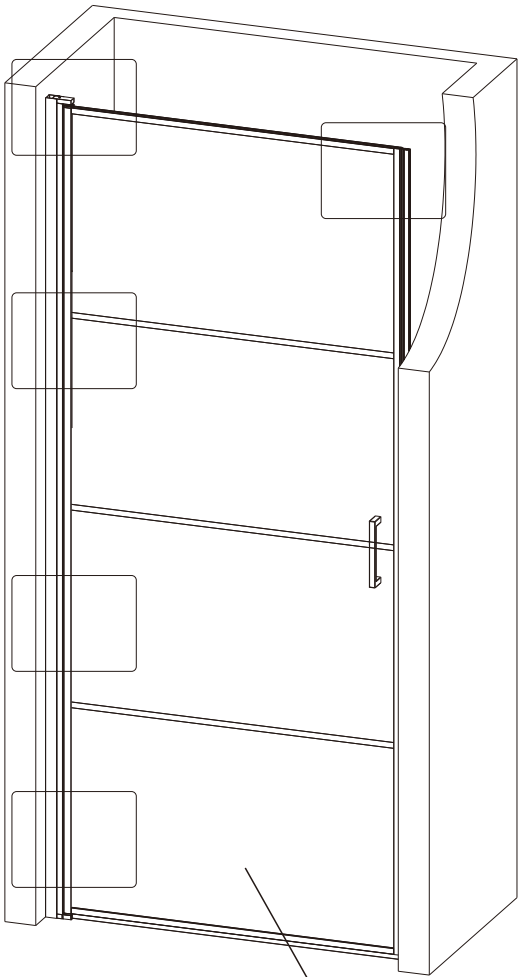

06

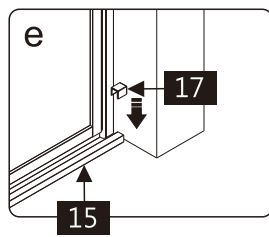
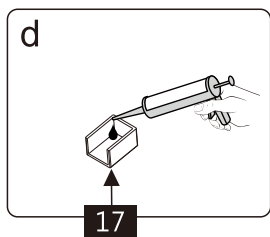
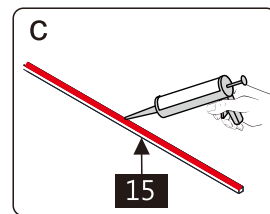
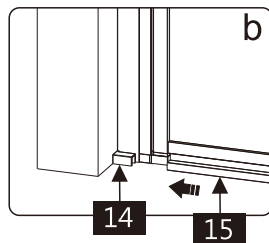
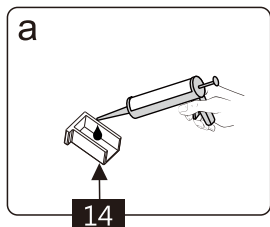
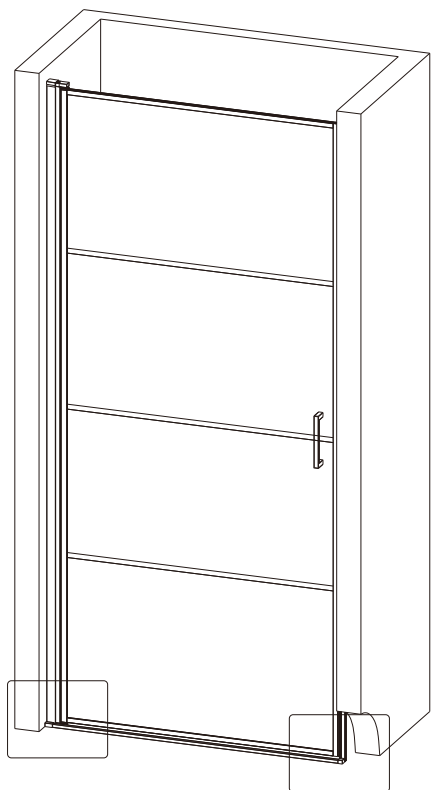

07

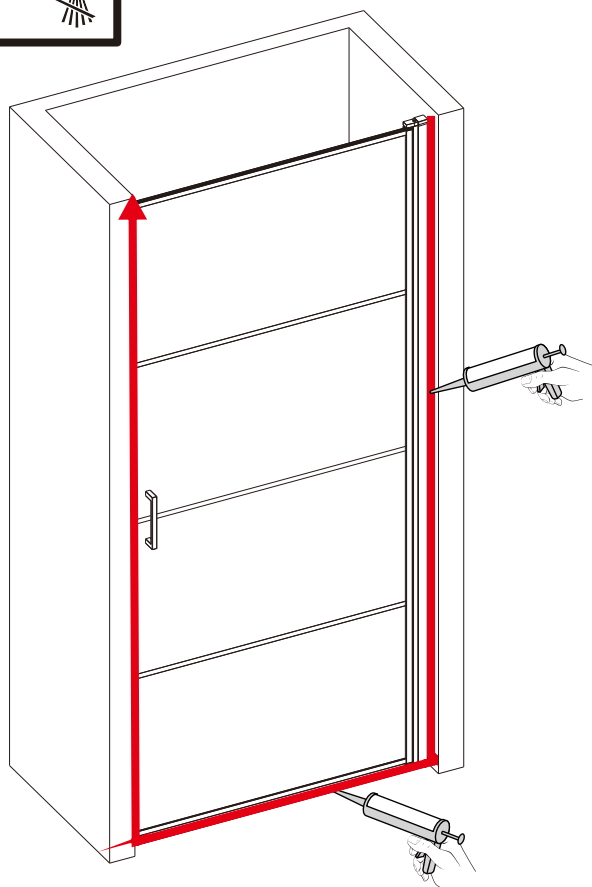
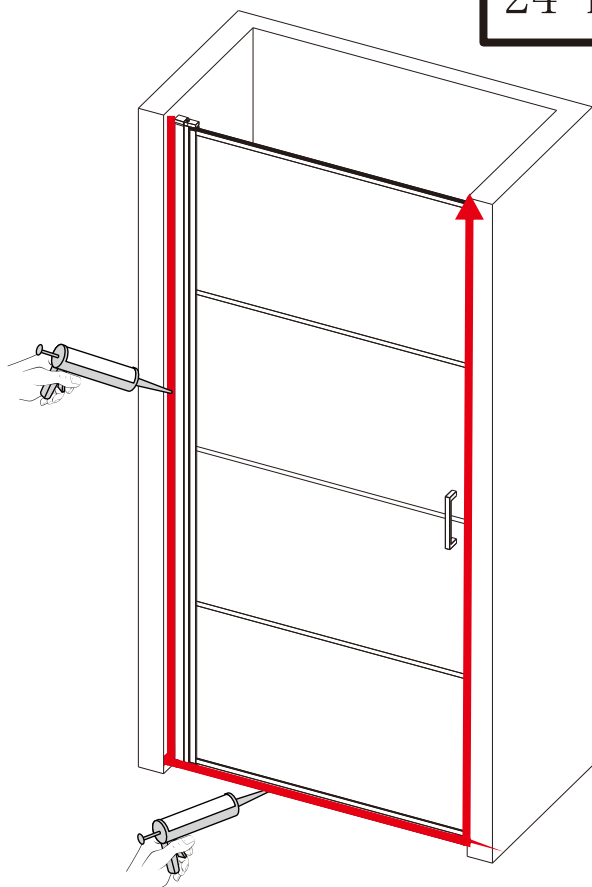
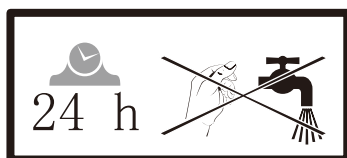

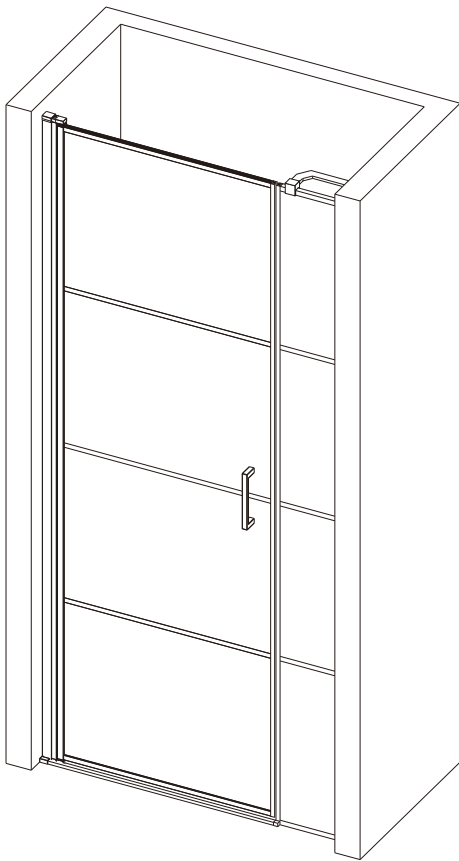

L

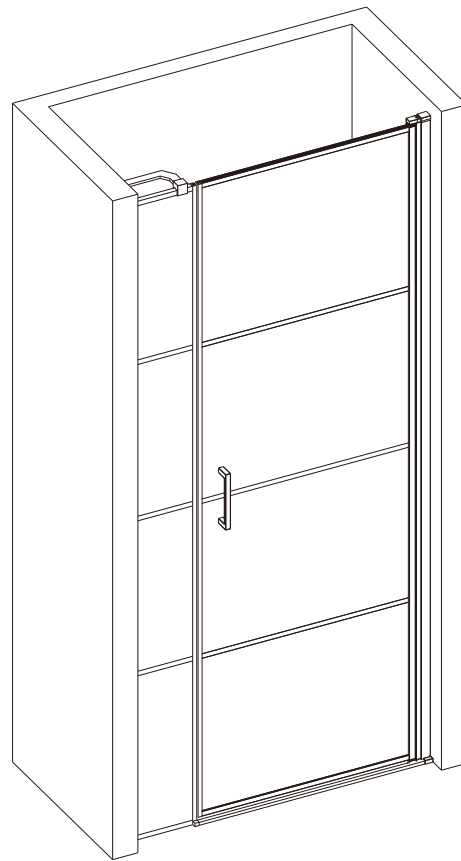

R

41190	700
41191	800
41192	900

+ 43054 + 43056

08

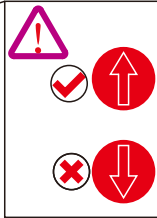
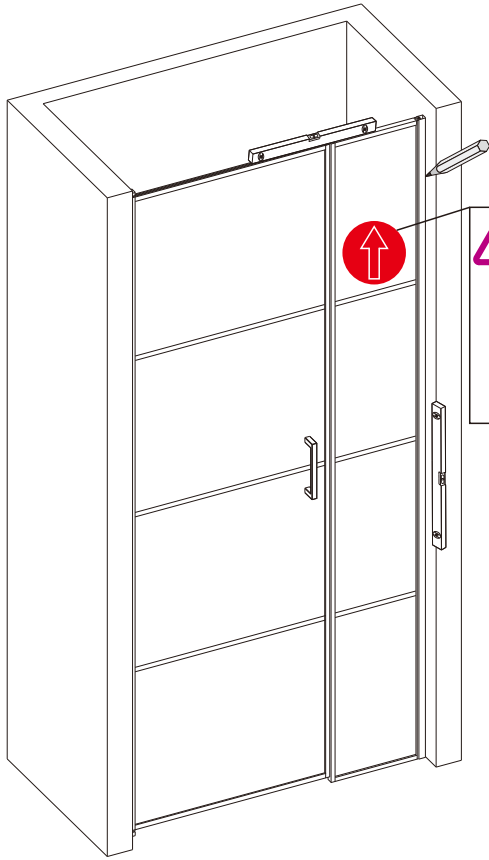

SIZE(mm)	A
41190+43054+43056	965~990
41191+43054+43056	1065~1090
41192+43054+43056	1165~1190

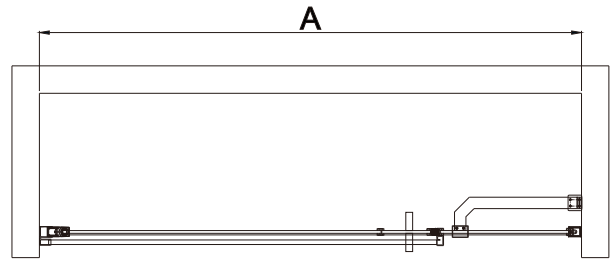

Note:
In consideration of the influence of walls and tiles, the actual installation size will be smaller than the size declared on the website, but it will not affect the normal usage. The adjustment shall be subject to the manual instructions.

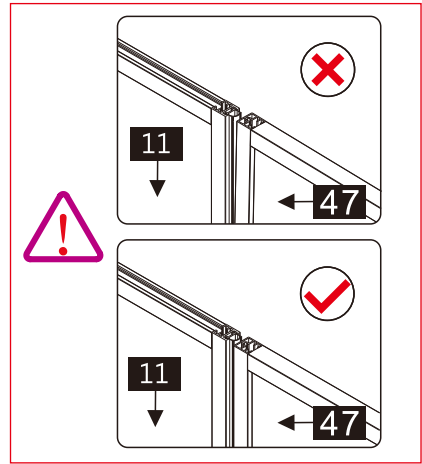
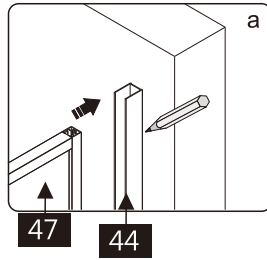

09

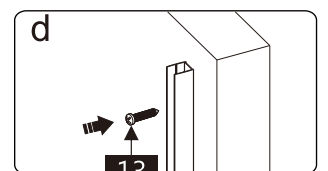
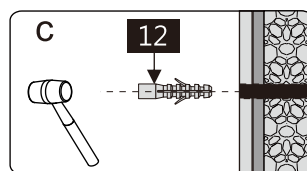
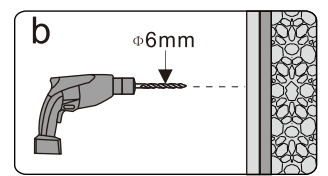
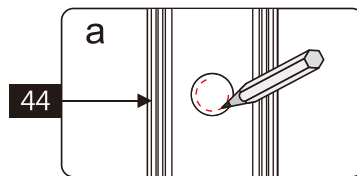
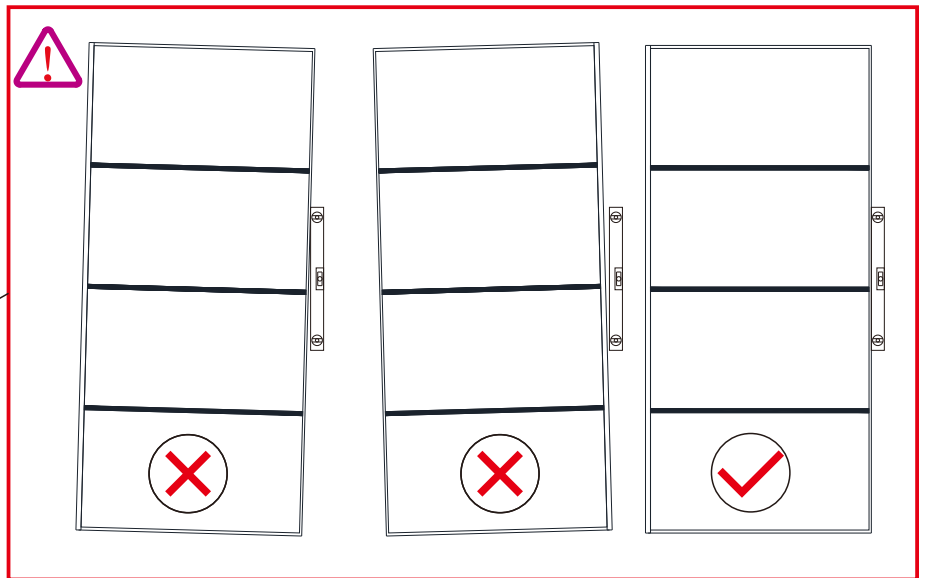
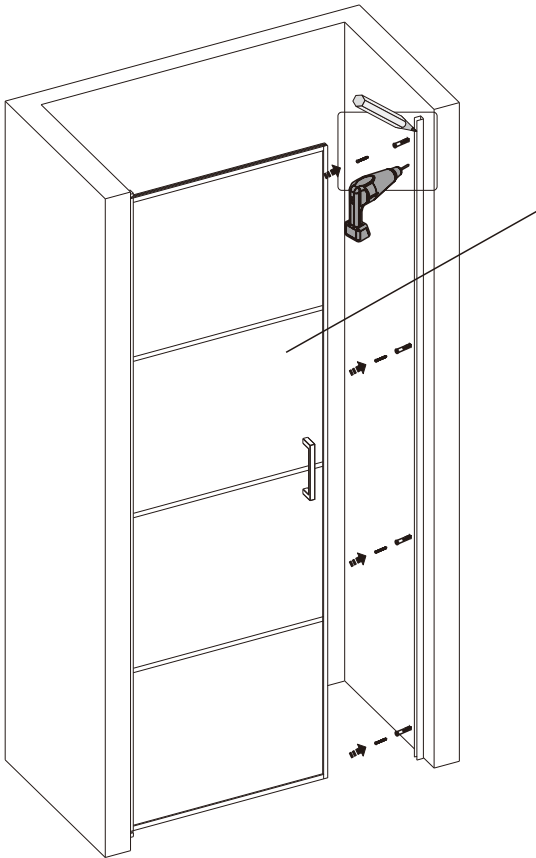

10

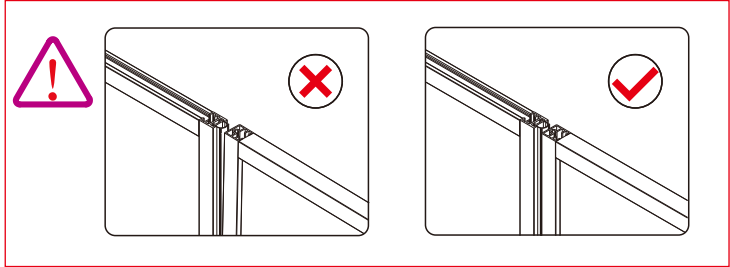
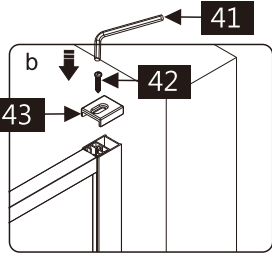
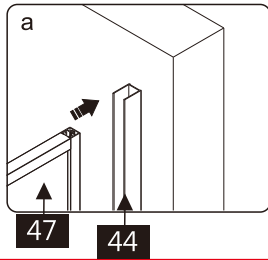
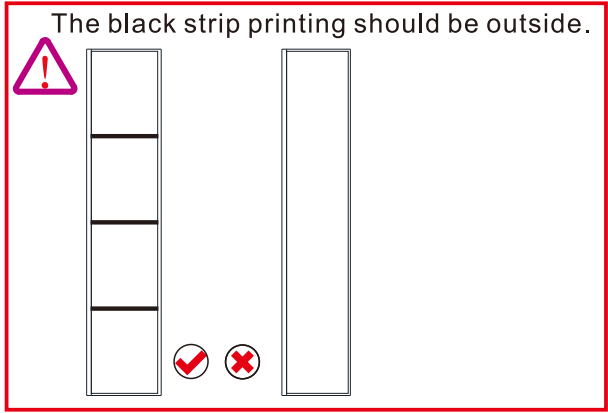
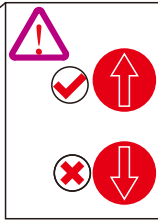
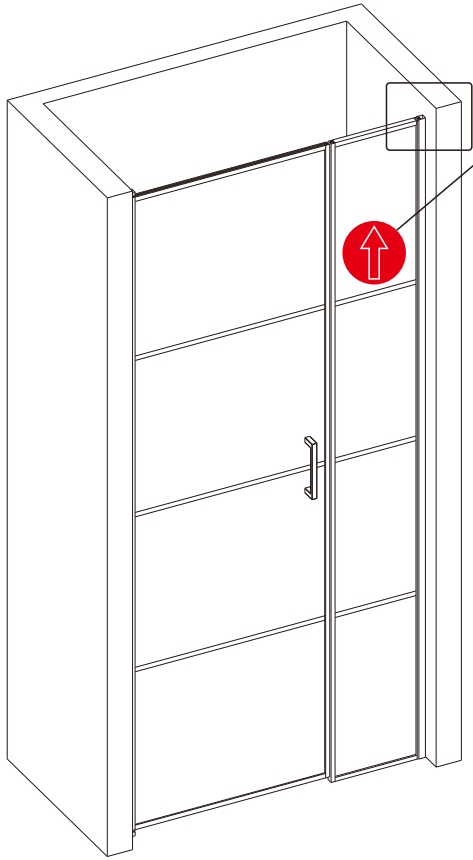

11

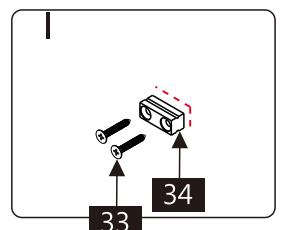
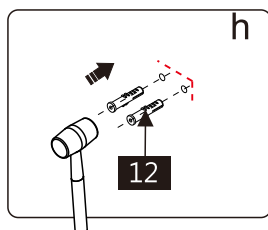
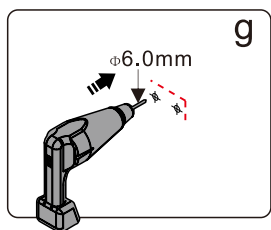
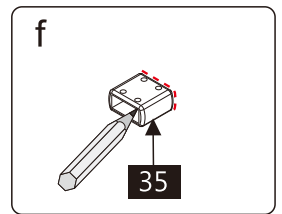
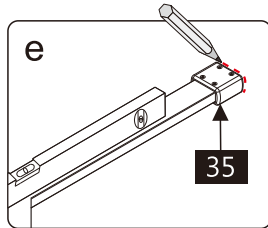
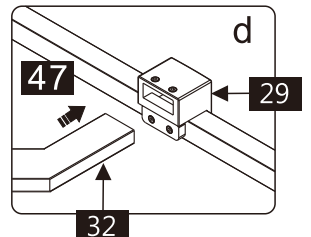
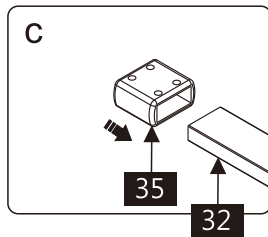
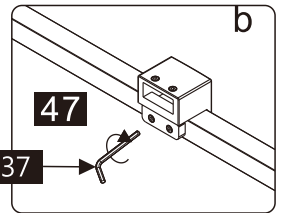
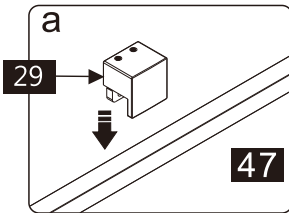

12

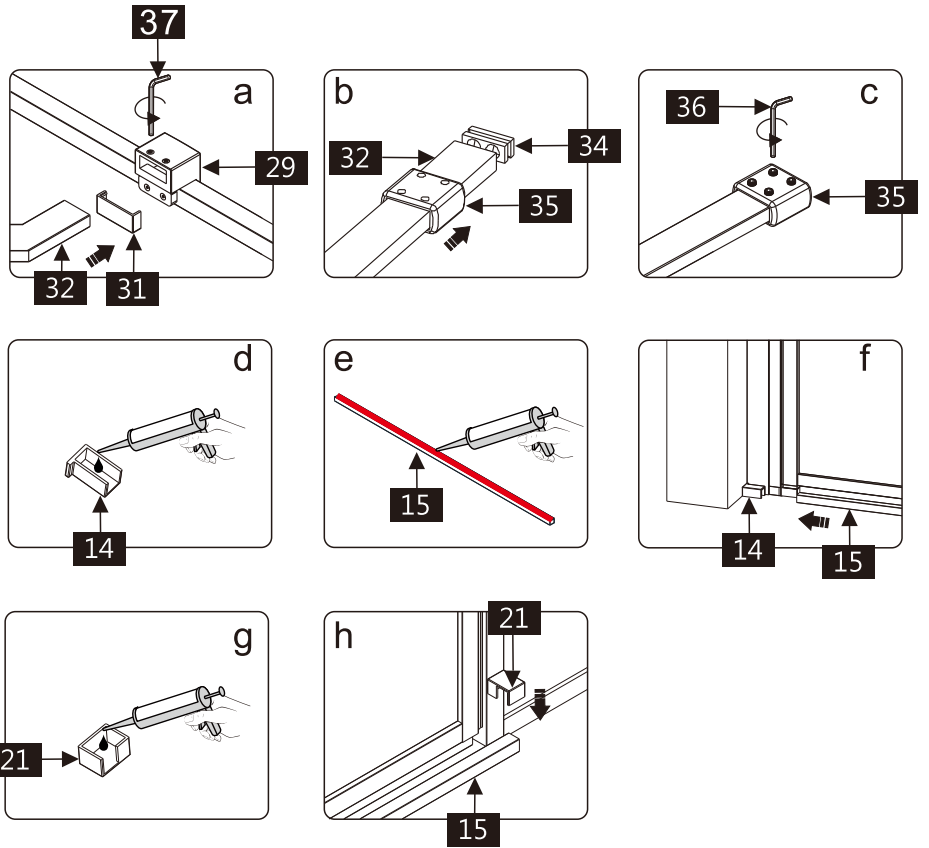

13

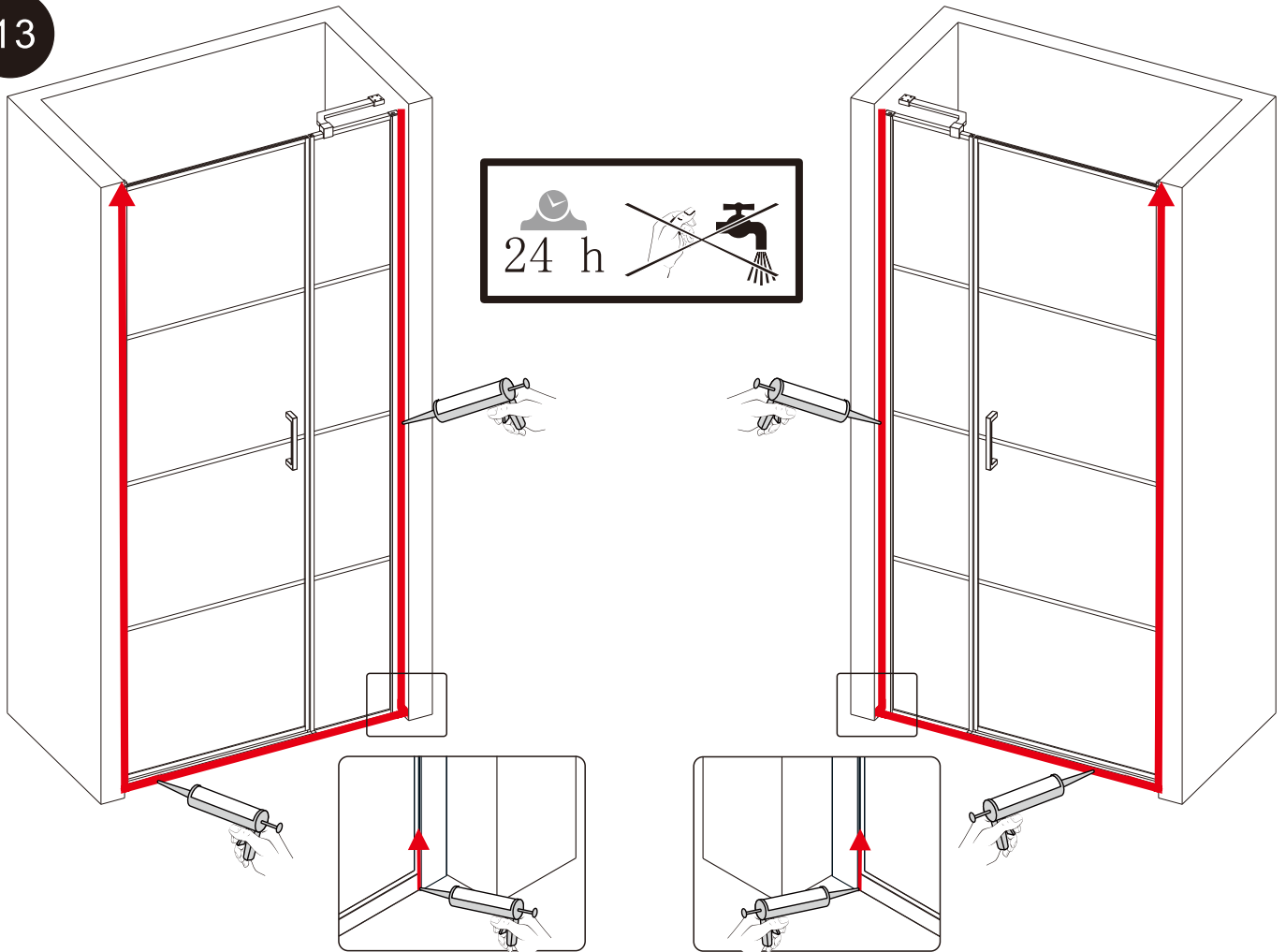

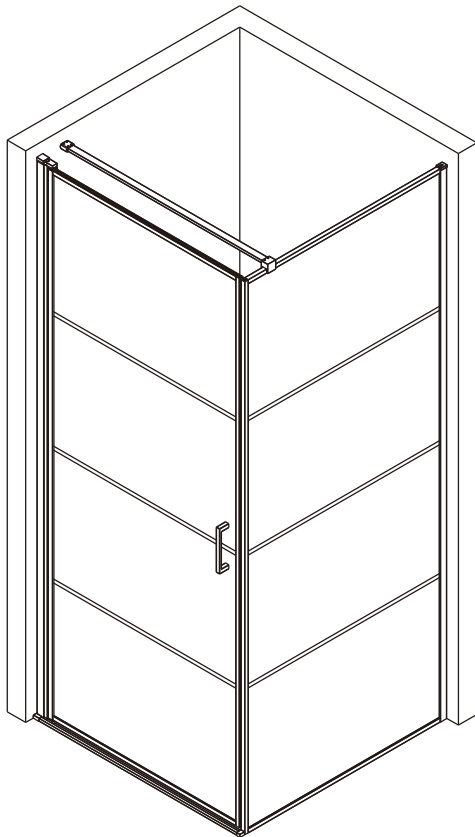

L

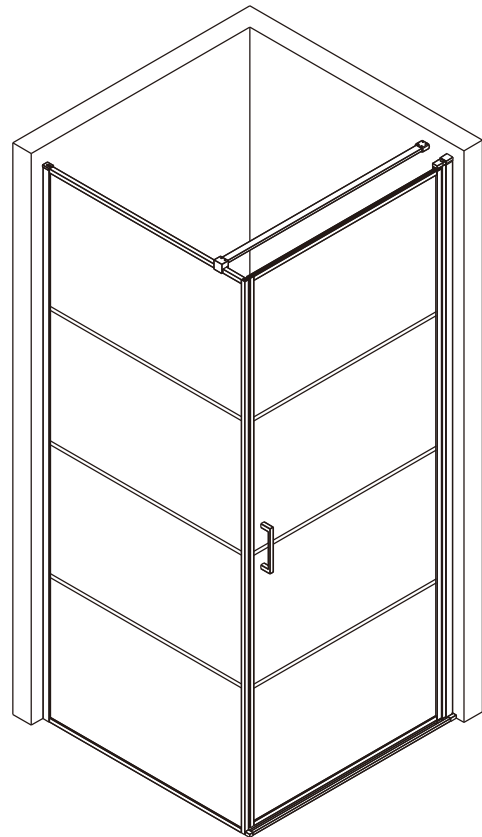

R

41190	700
41191	800
41192	900

+

41206	700
41193	800
41194	900

14

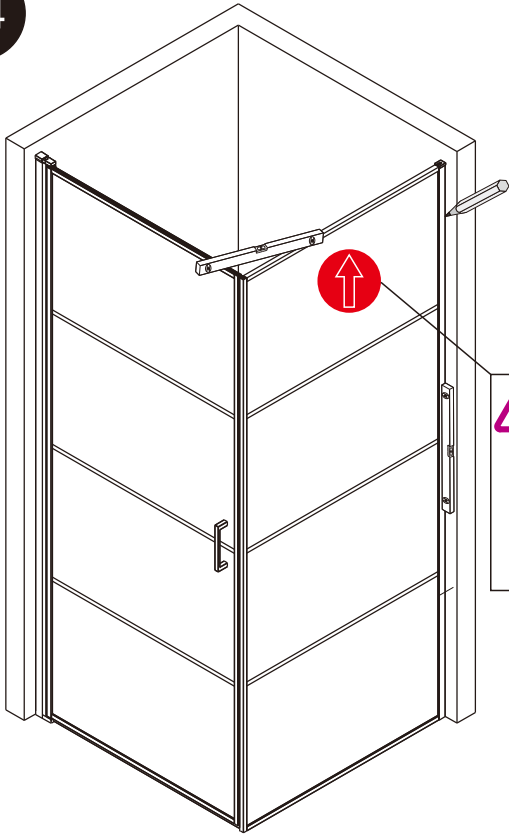

SIZE(mm)	A
41190	675~690
41191	775~790
41192	875~890
SIZE(mm)	B
41206	680~690
41193	780~790
41194	880~890

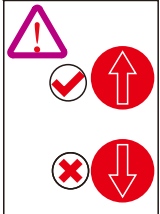
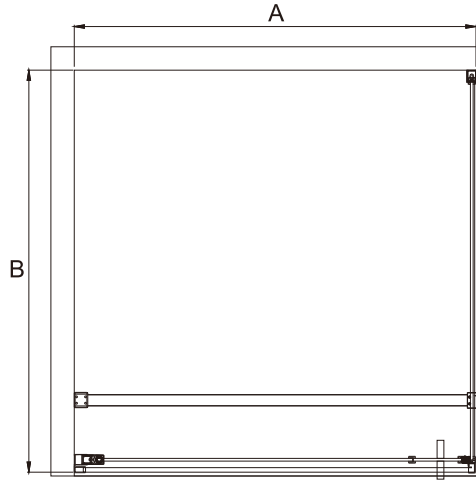

Note:
In consideration of the influence of walls and tiles, the actual installation size will be smaller than the size declared on the website, but it will not affect the normal usage. The adjustment shall be subject to the manual instructions.

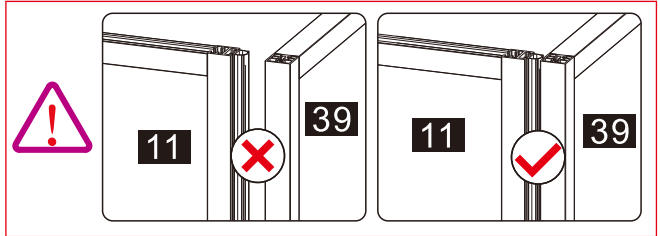
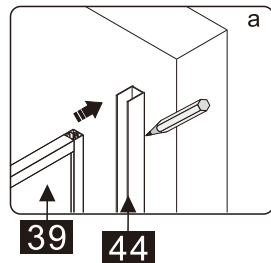

15

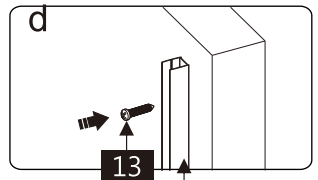
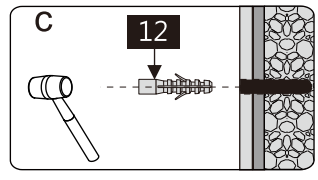
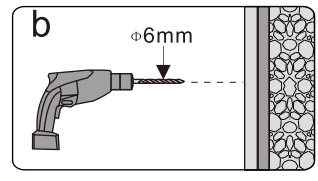
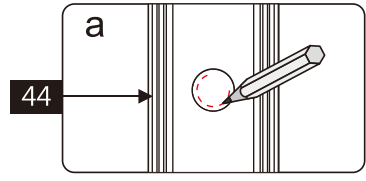
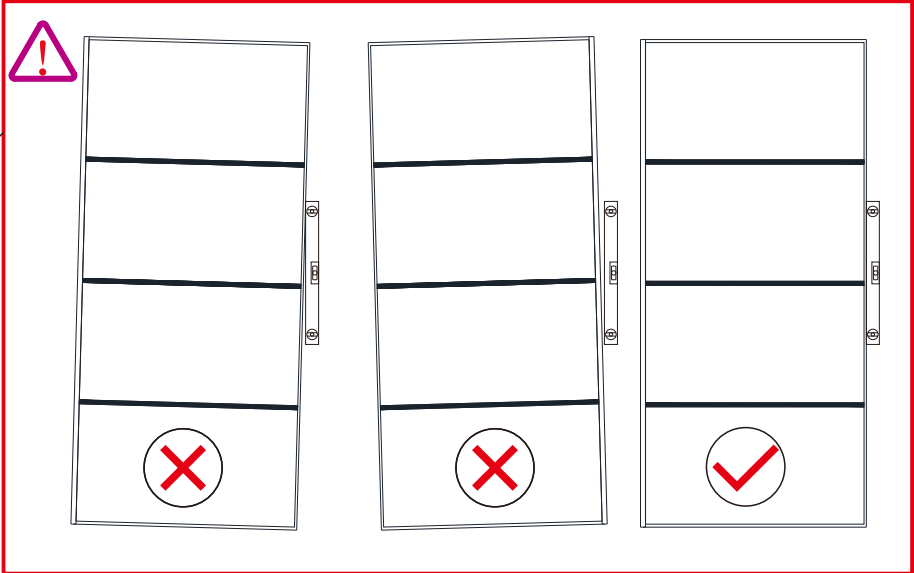
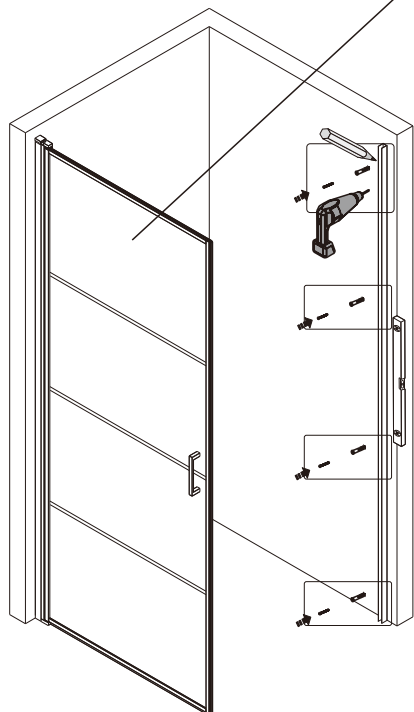

16

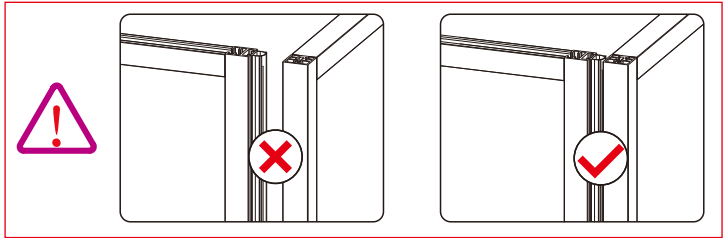
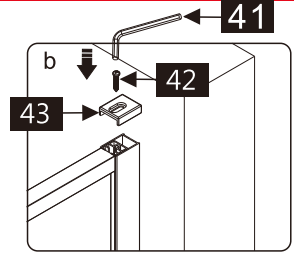
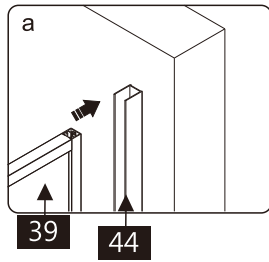
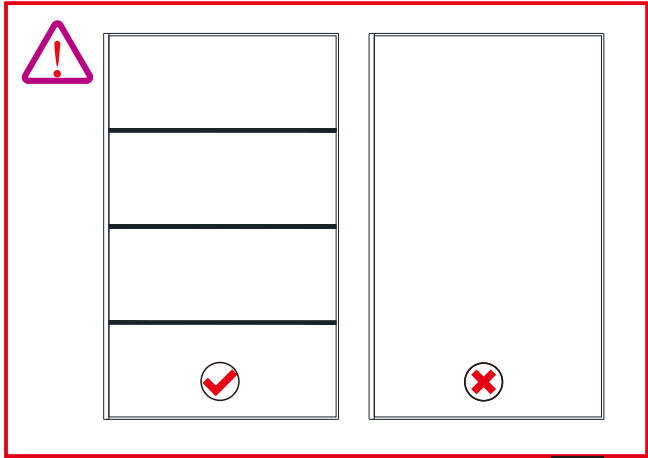
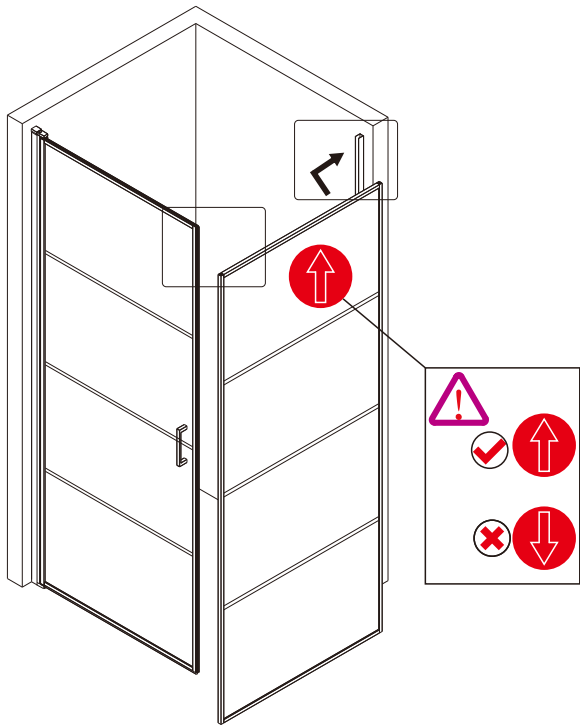

17

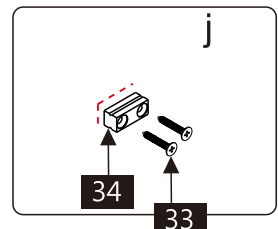
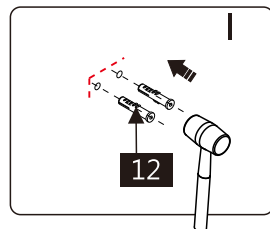
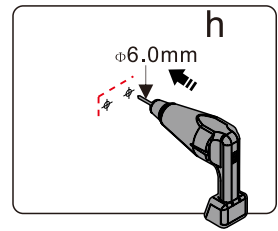
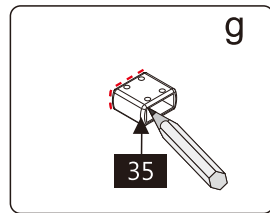
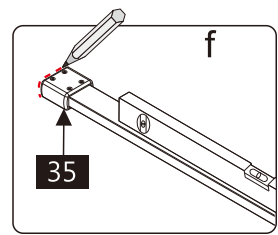
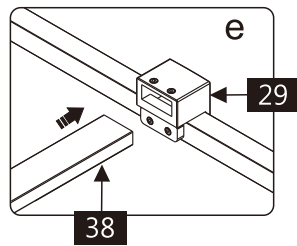
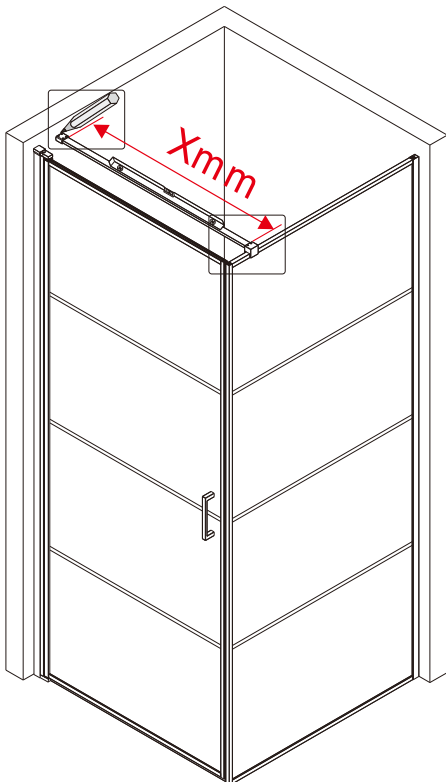
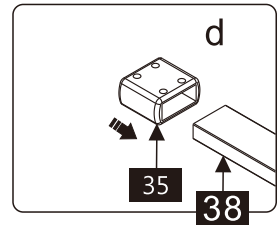
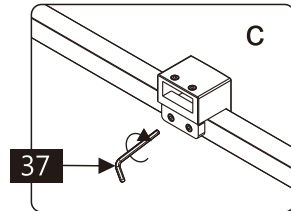
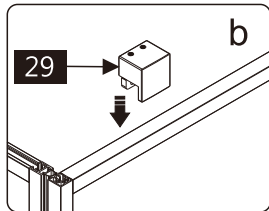
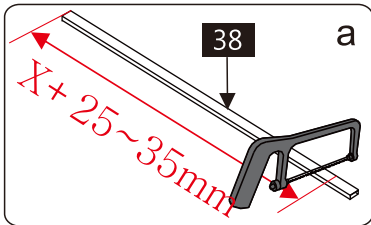

18

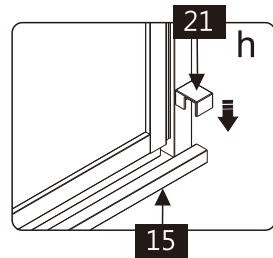
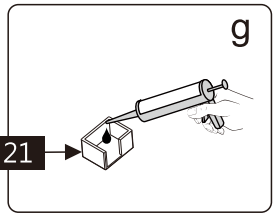
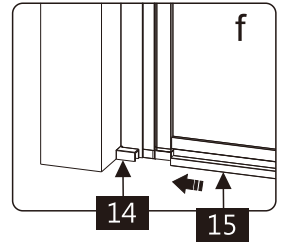
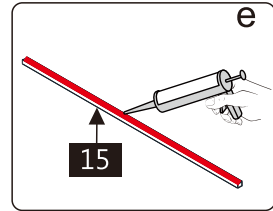
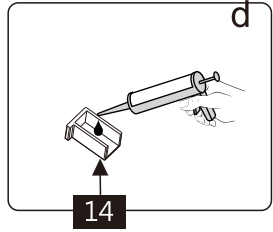
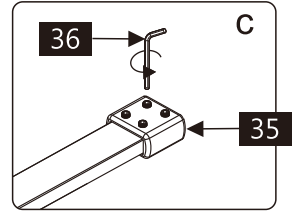
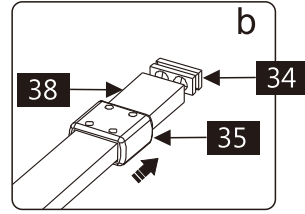
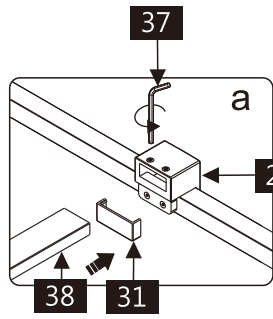
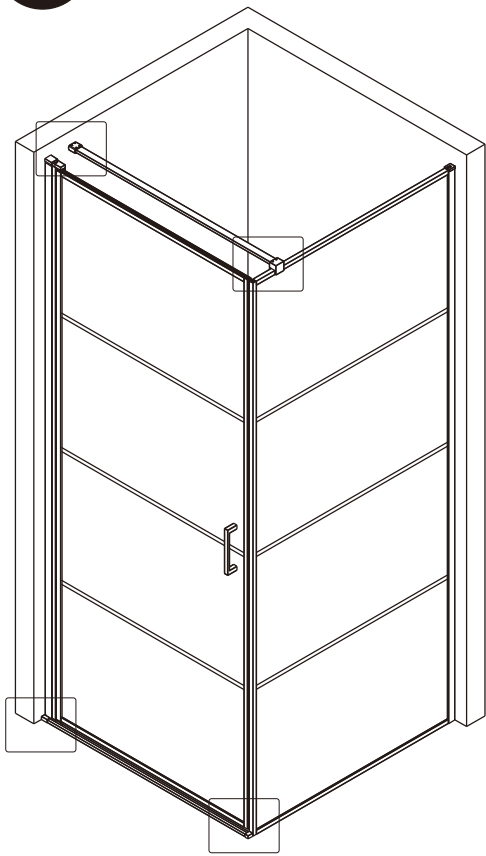

19

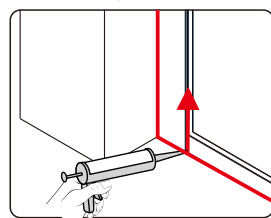
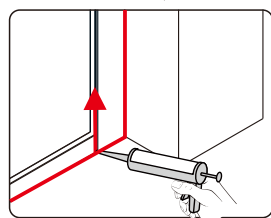
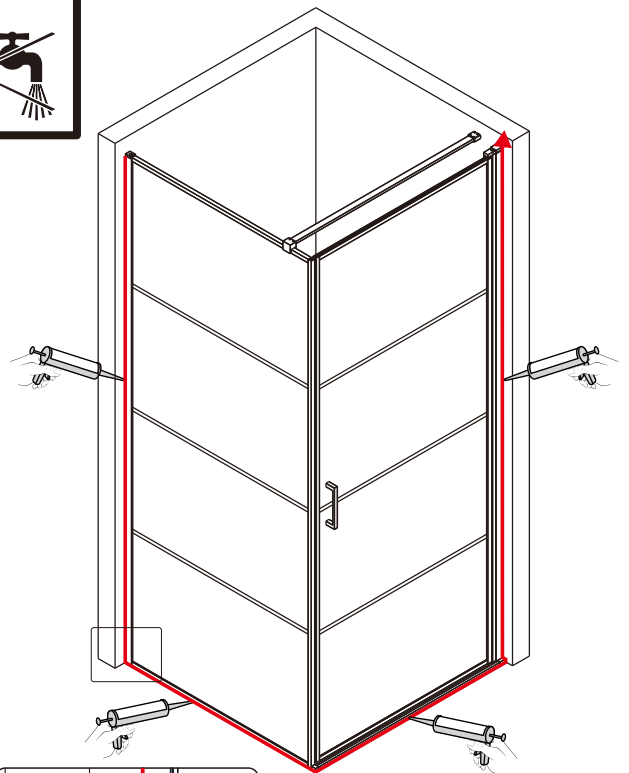
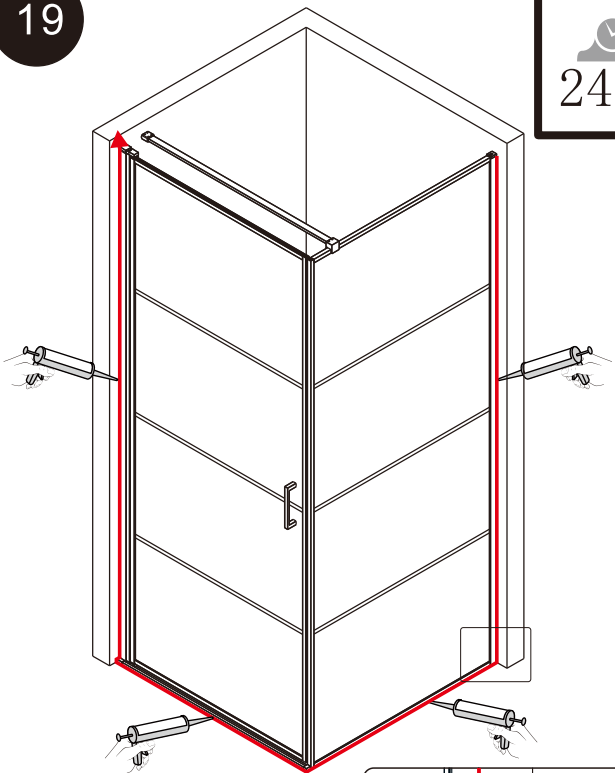

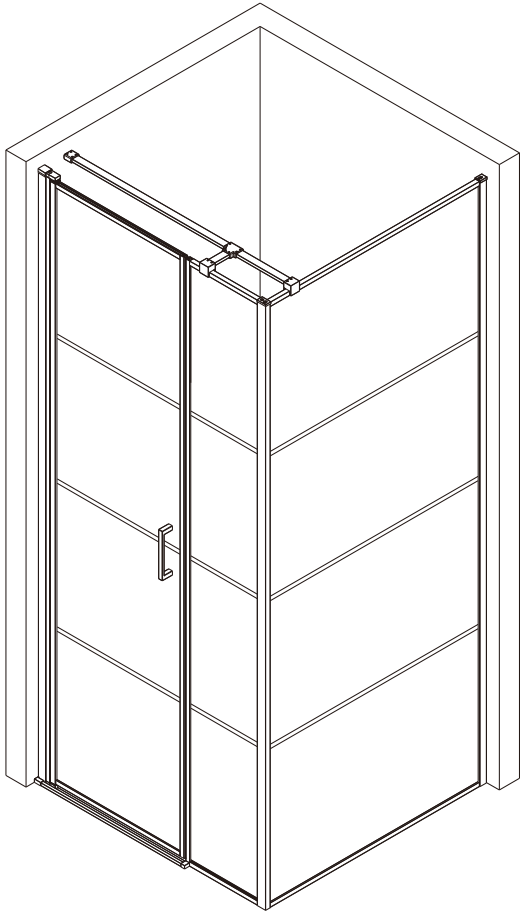

L

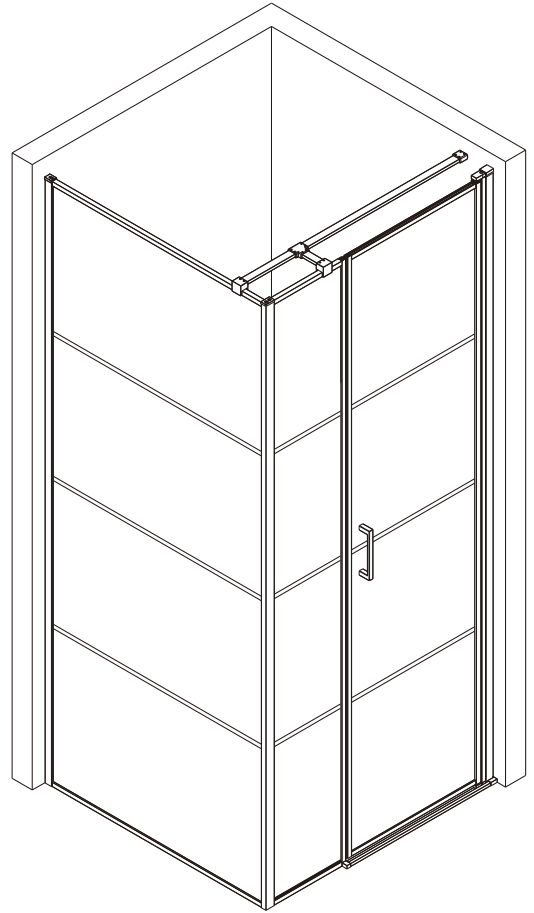

R

41190	700		41206	700				
41191	800	+	41193	800	+	43054	+	43055
41192	900		41194	900				

SIZE(mm)	A
41190+43054+43055	975~990
41191+43054+43055	1075~1090
41192+43054+43055	1175~1190
SIZE(mm)	B
41206	680~690
41193	780~790
41194	880~890

Note:
In consideration of the influence of walls and tiles, the actual installation size will be smaller than the size declared on the website, but it will not affect the normal usage. The adjustment shall be subject to the manual instructions.

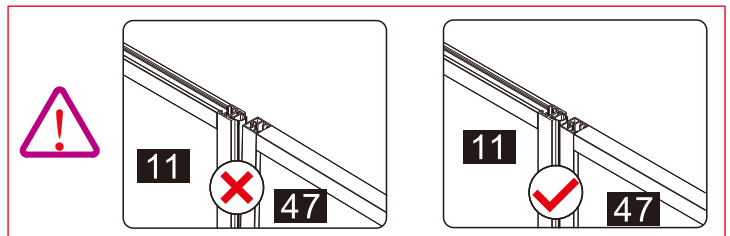
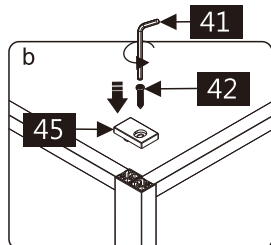
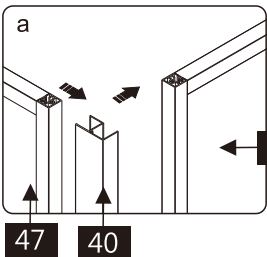
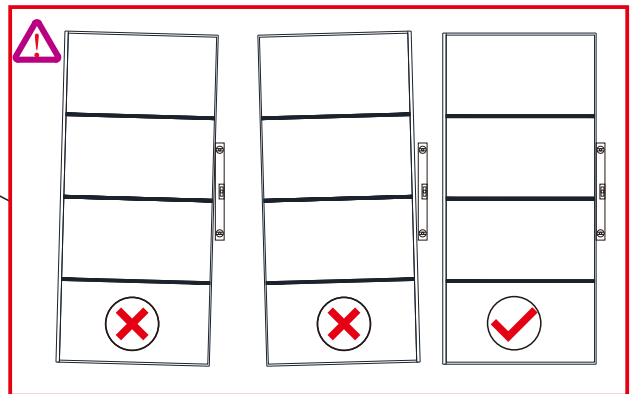
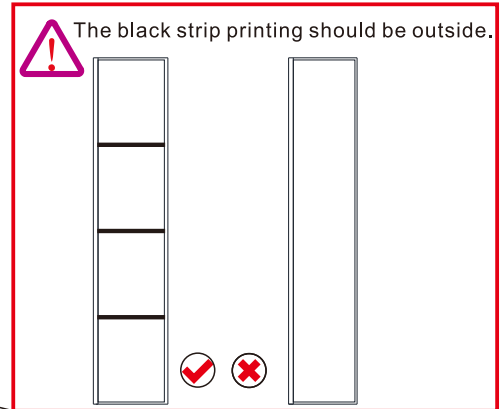
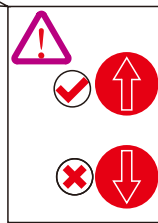
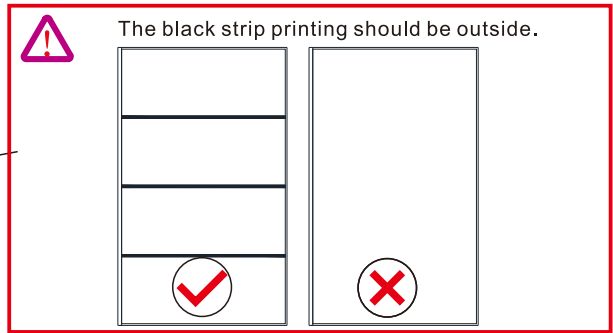
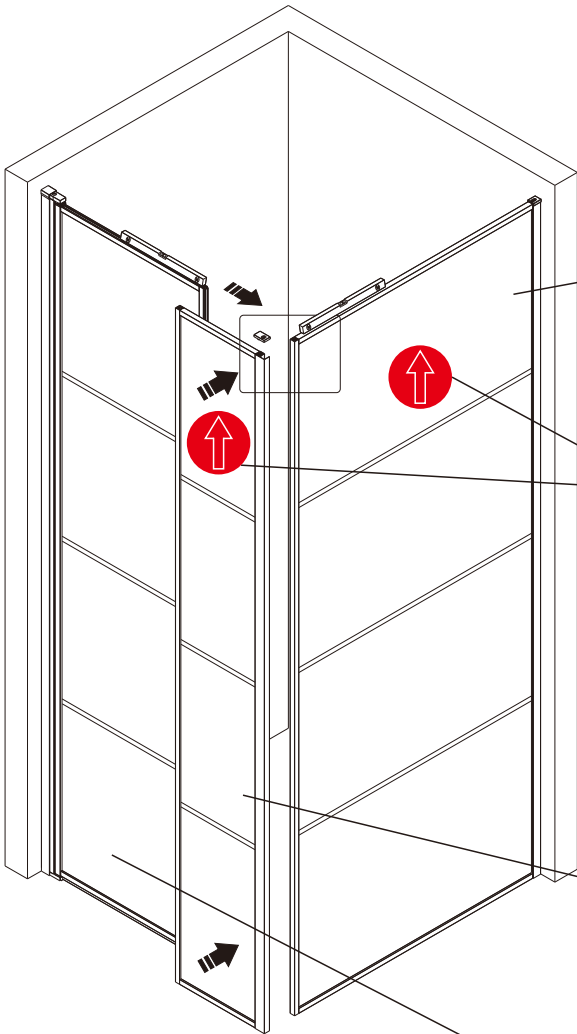
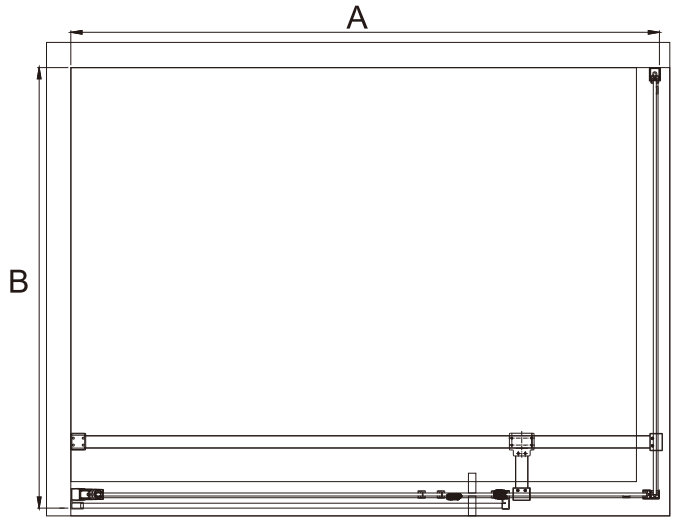

21

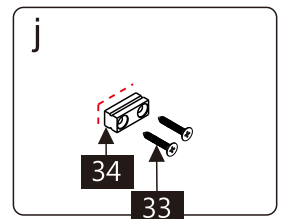
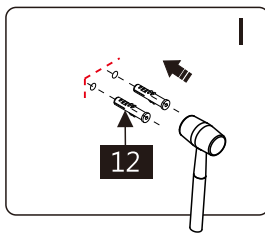
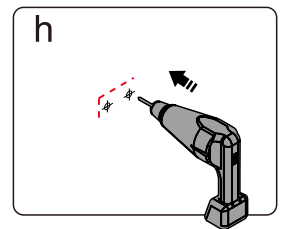
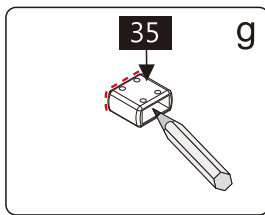
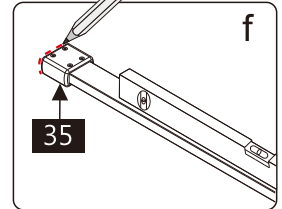
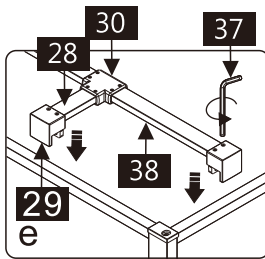
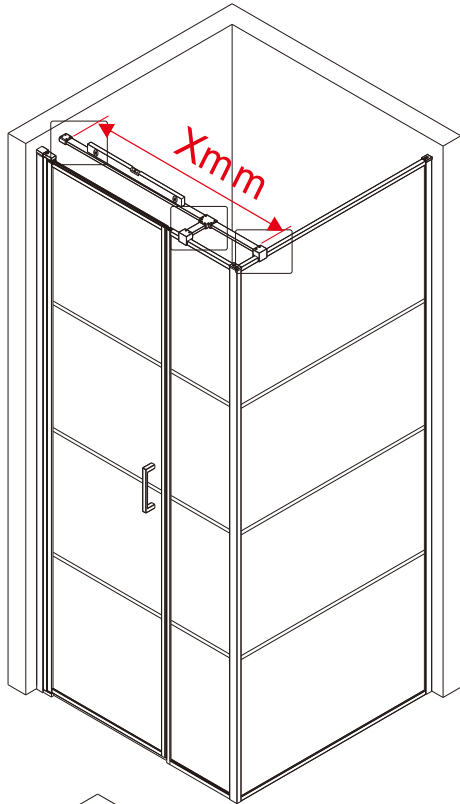
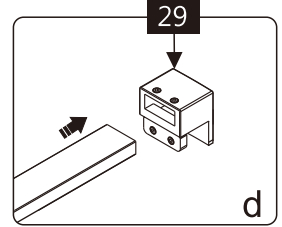
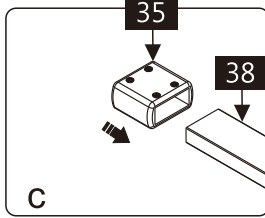
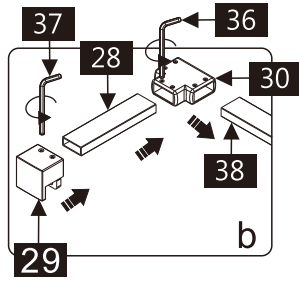
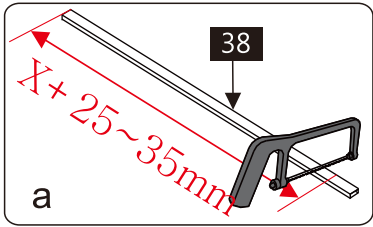

22

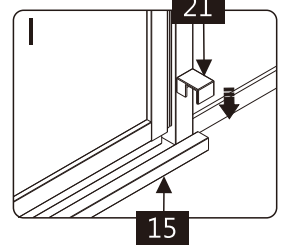
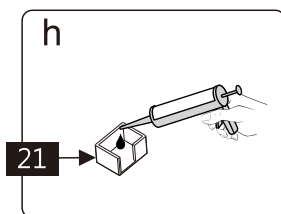
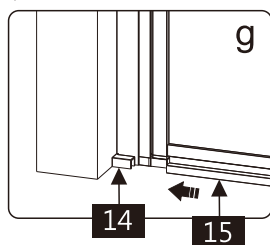
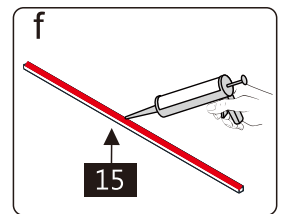
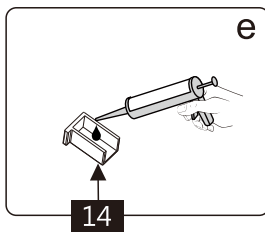
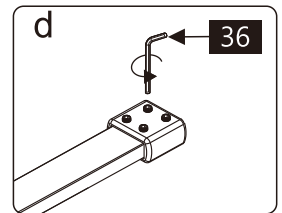
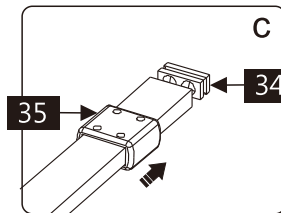
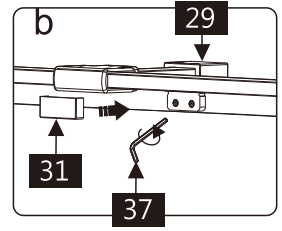
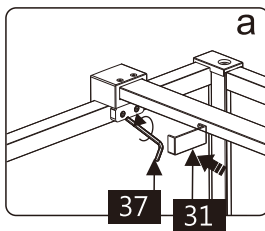
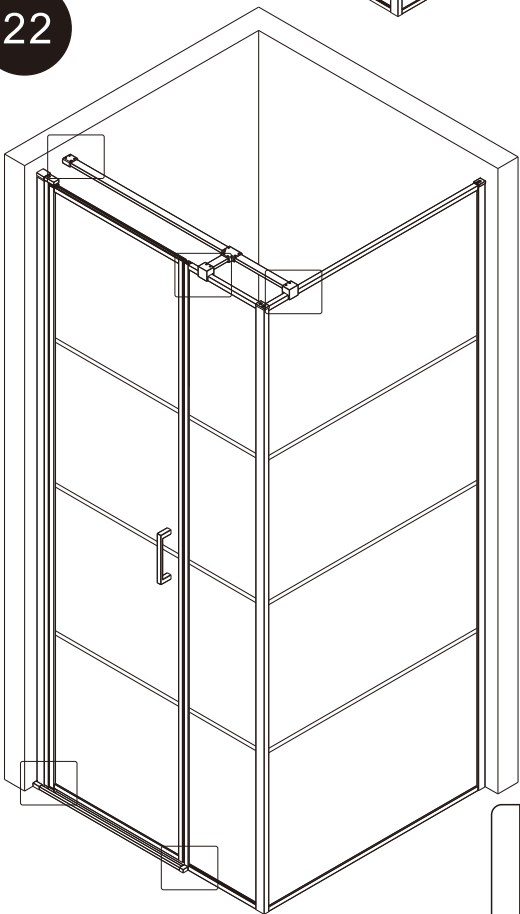

23

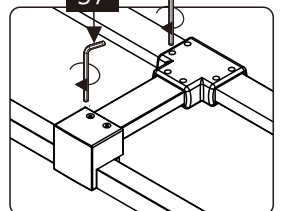
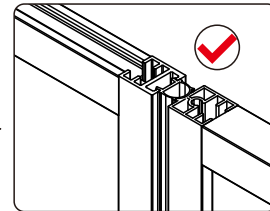
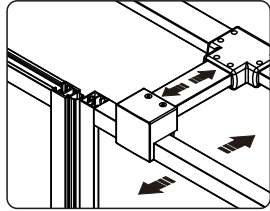
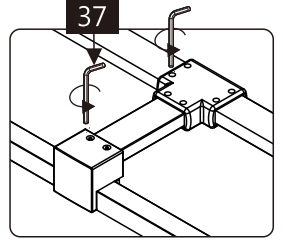
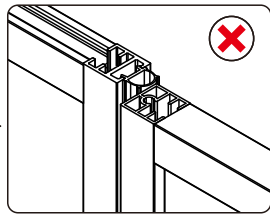
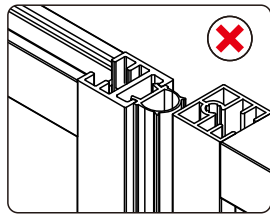
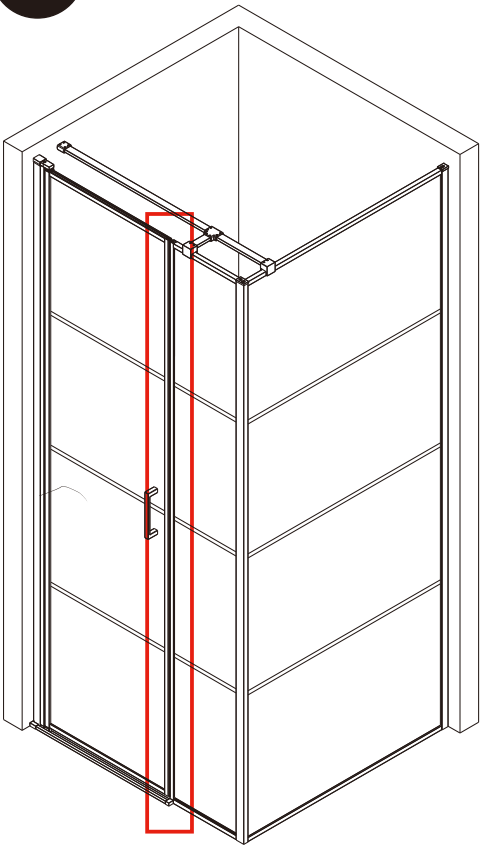

24

