

Installation Manual

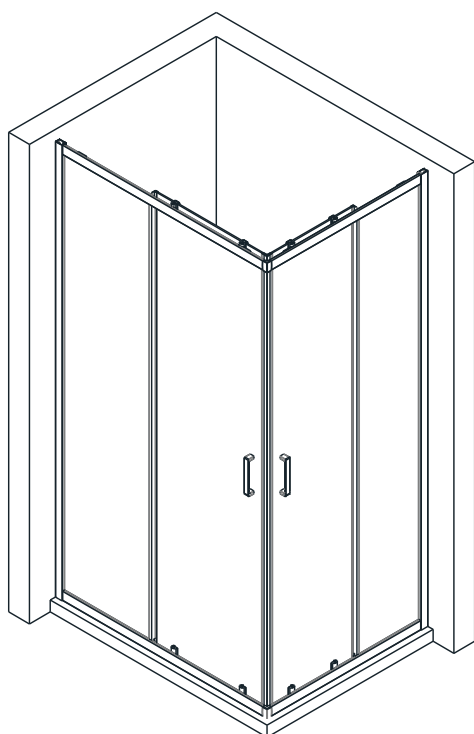

L

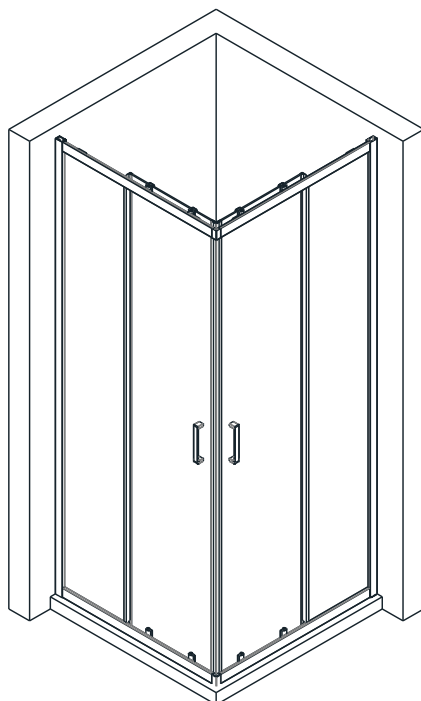
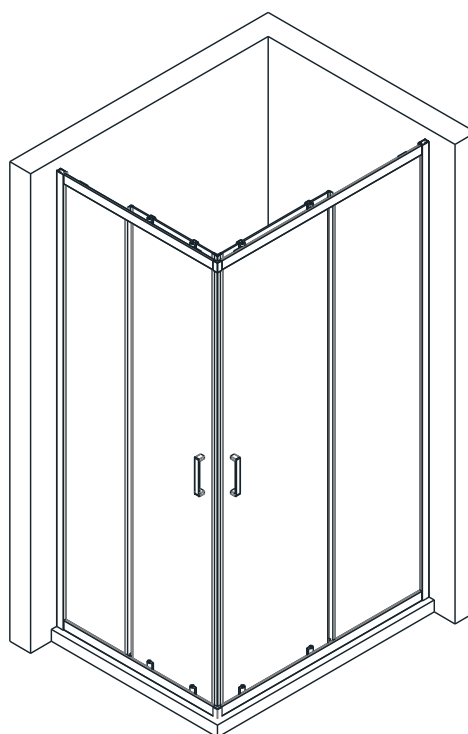

R

Apply for following models:

41202/41203/41204

this page for your online registration.

No. FIENSEB43V2.0



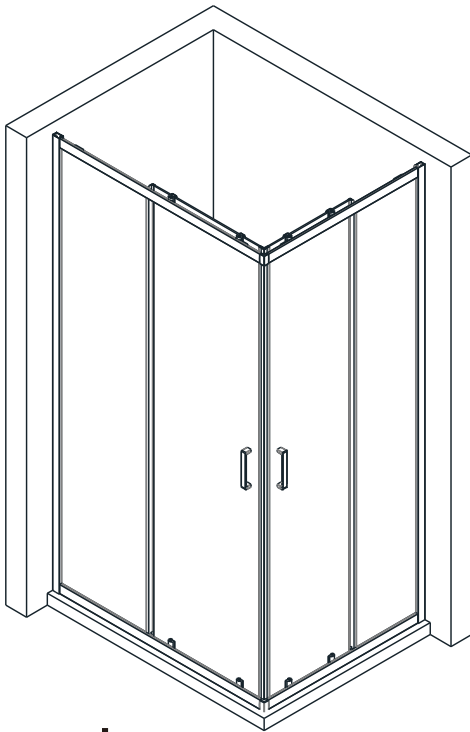
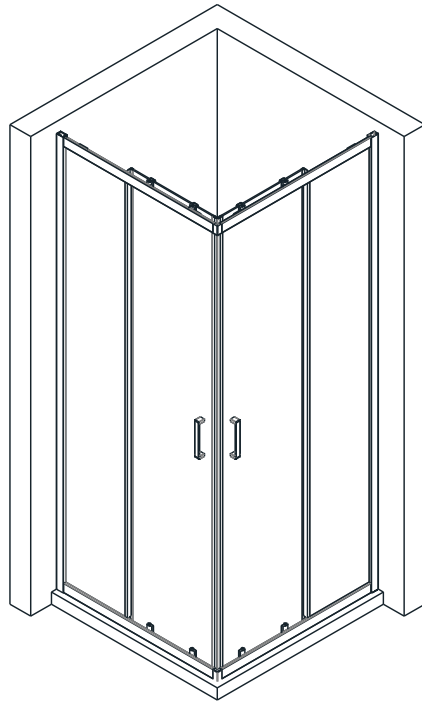

L

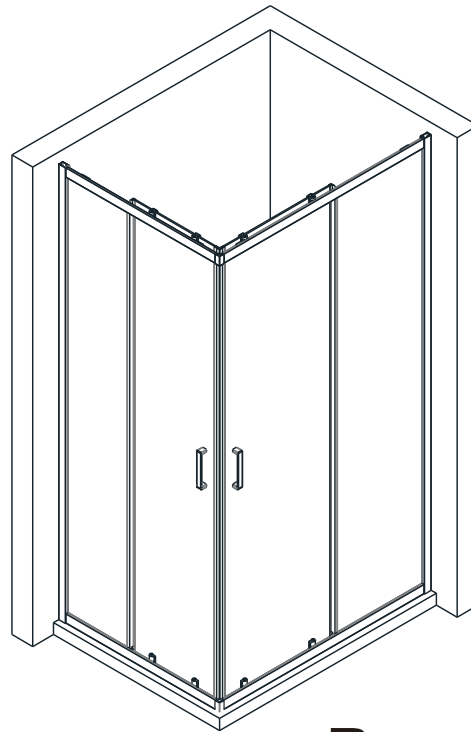





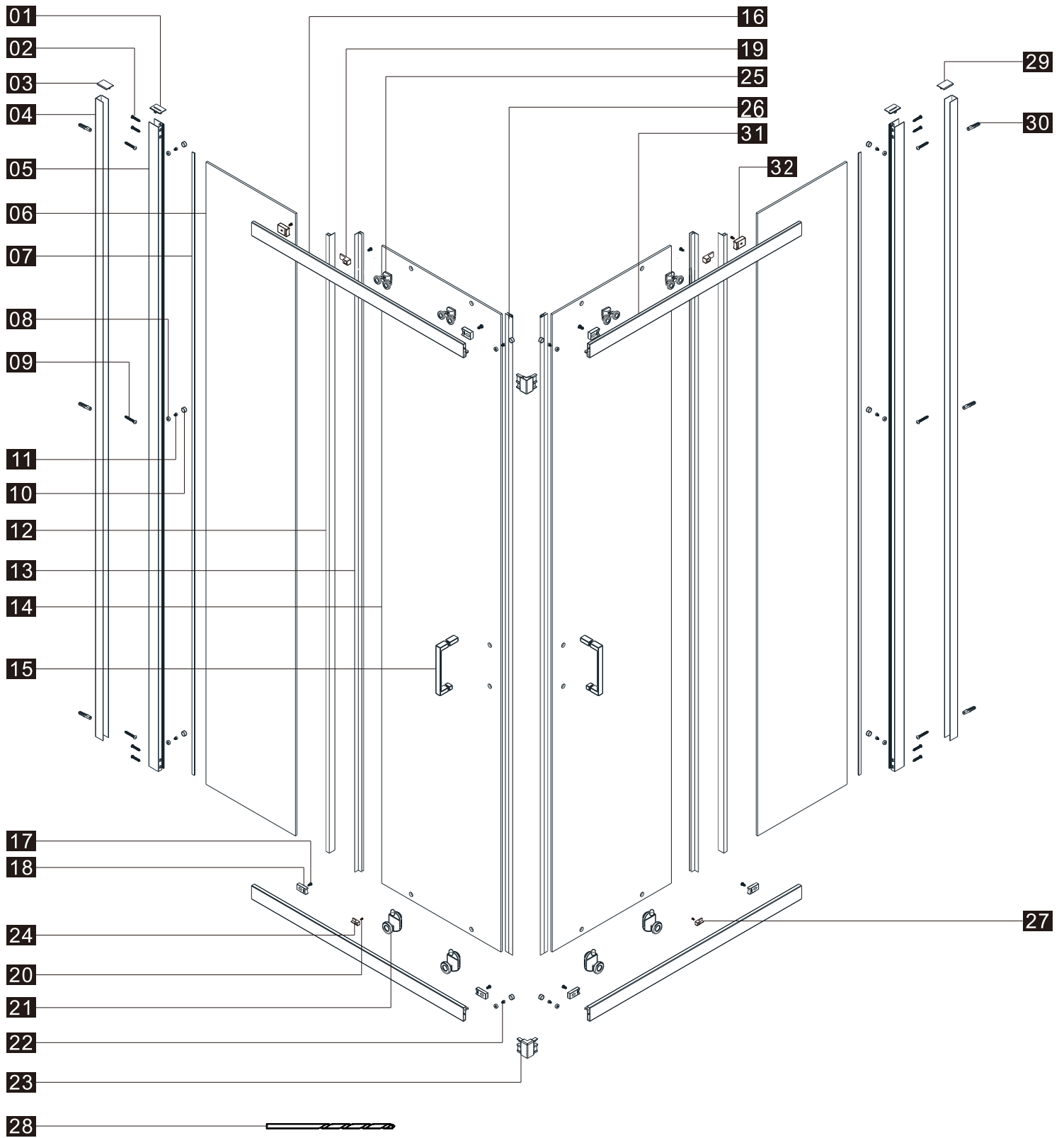









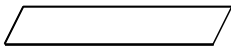

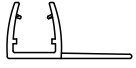
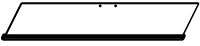
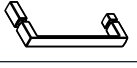

R

41202	760	760
41203	800	800
41204	900	900











Attention: Before installation, please check whether the number and type of accessories are correct, and then install them. If there is any problem, please inform us as soon as possible. Thank you!

Parts List

Part Number	Image	Size(mm)	Quantity	Remark
01			2	
02		ST3.5X30	8	
03			1	L Side
04		1850	2	Aluminum profile
05		1850	2	Aluminum profile
06			2	
07		1786	2	Seal
08			10	
09		ST4X35	6	
10			10	
11		ST4X10	6	
12		1770	2	Seal
13		1830	2	Seal
14			2	
15			2	
16			2	Aluminum profile
17		ST4X10	8	
18			4	Long
19			2	
20		ST4X14	4	
21			4	
22		ST3.5X8	4	
23			2	

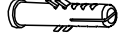
Parts List

Part Number	Image	Size(mm)	Quantity	Remark
24			1	R side
25			4	
26		A 、 B	1	Magnetic seal
27			1	L Side
28		φ2.8mm	1	
29			1	R side
30			6	
31			2	Aluminum profile
32			4	Short

You will need

To assemble your product (Tools not provided).

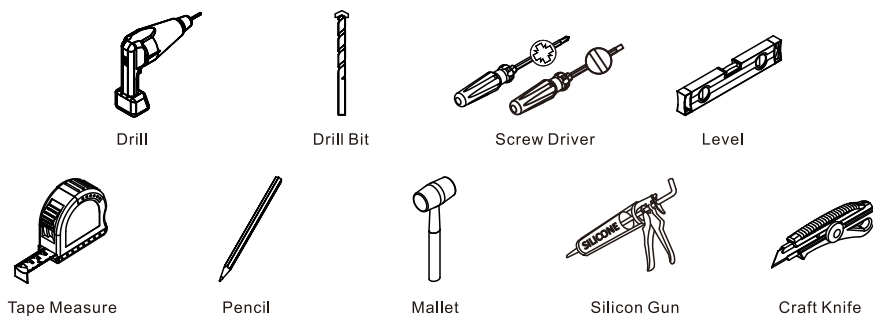

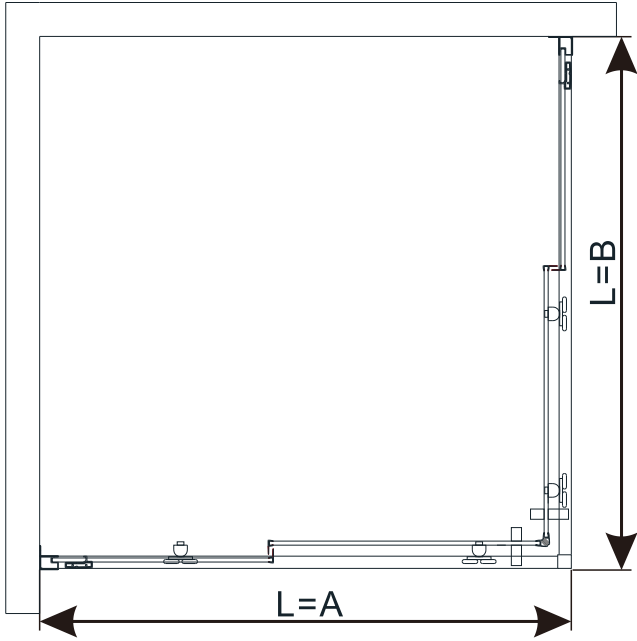

SIZE	A	B
41202	735-750	735-750
41203	775-790	775-790
41204	875-890	875-890

Note:
In consideration of the influence of walls and tiles, the actual installation size will be smaller than the size declared on the website, but it will not affect the normal usage. The adjustment shall be subject to the manual instructions.

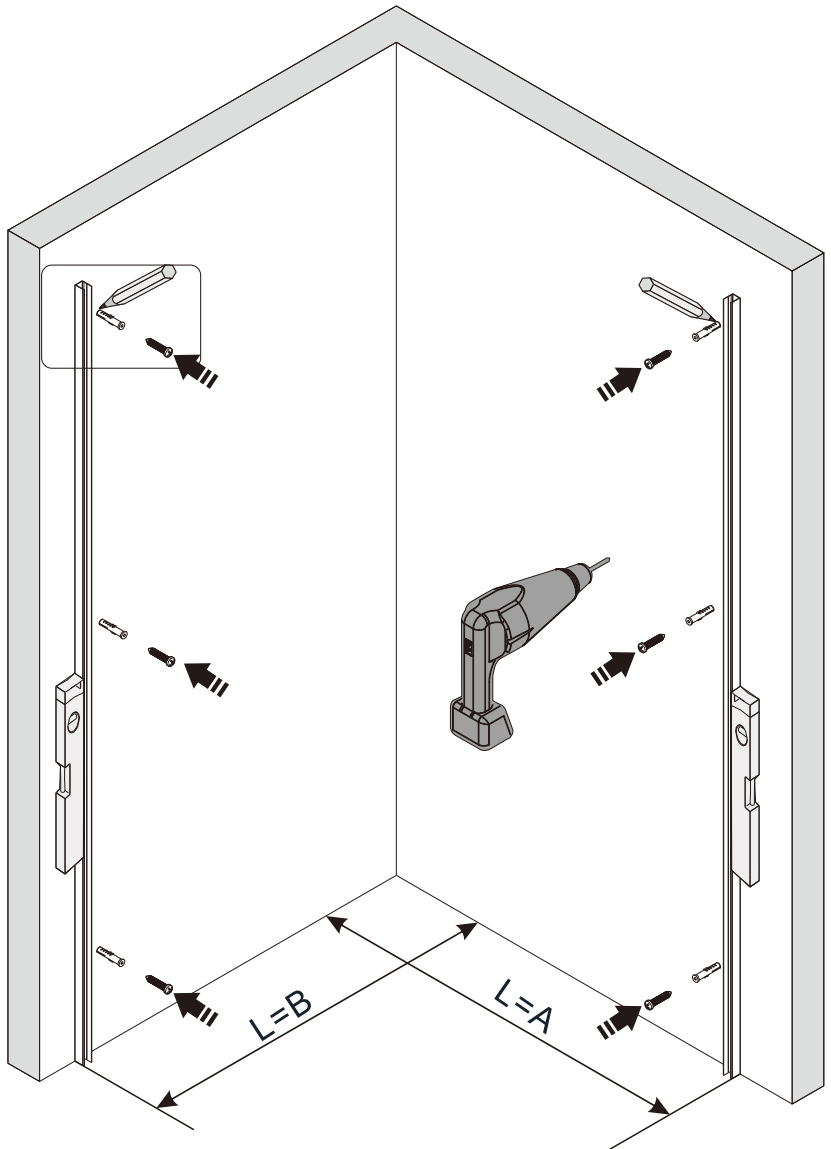
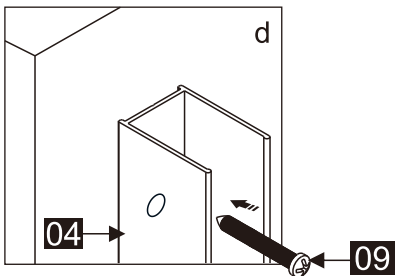
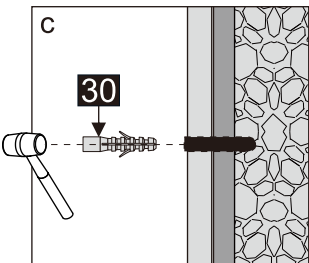
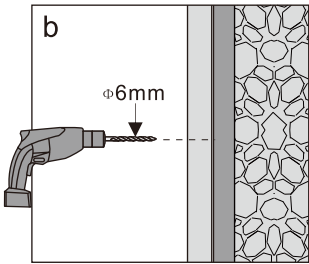
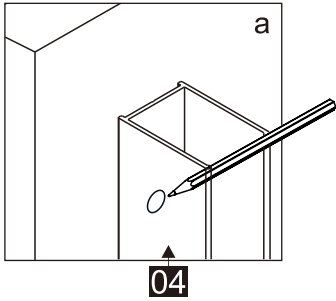

02

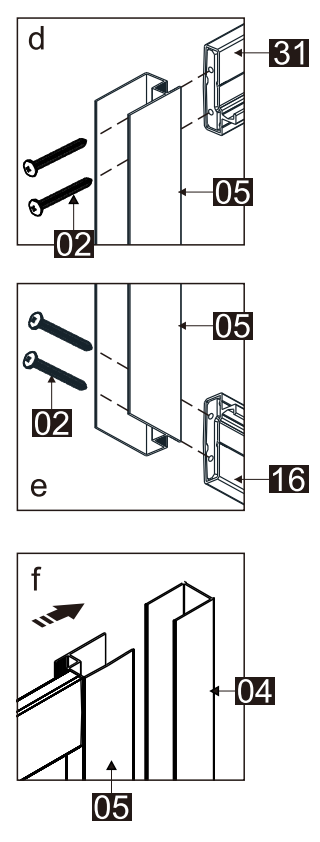
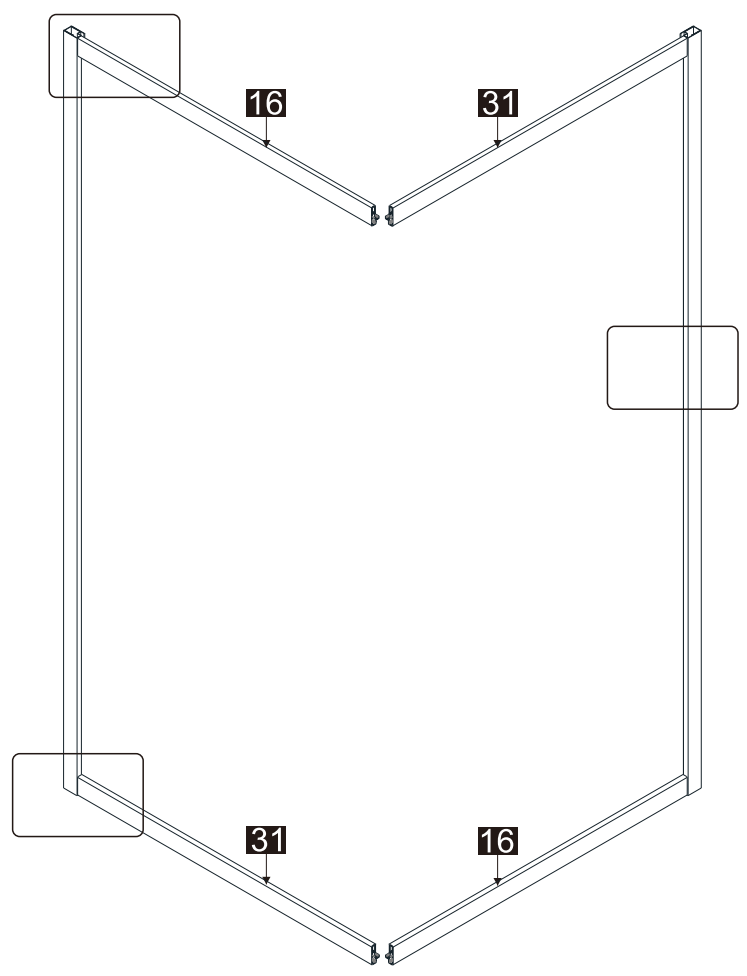
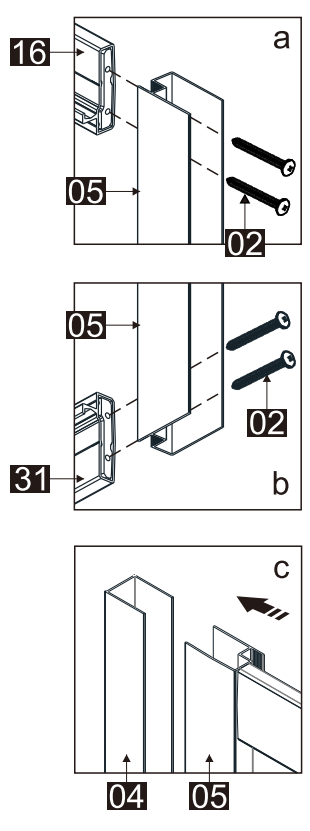

03

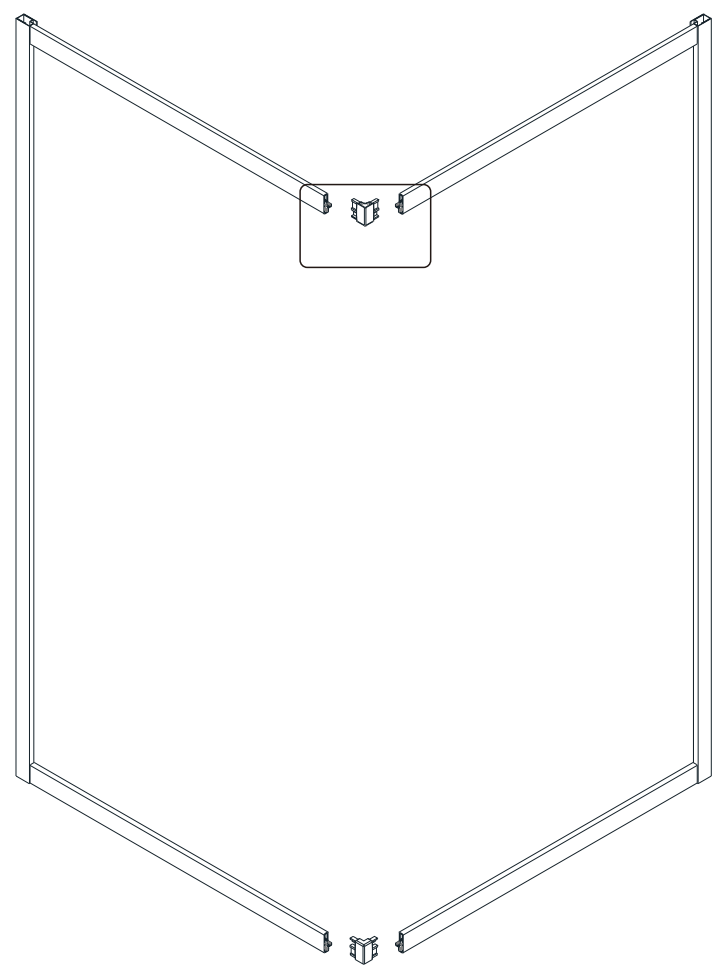
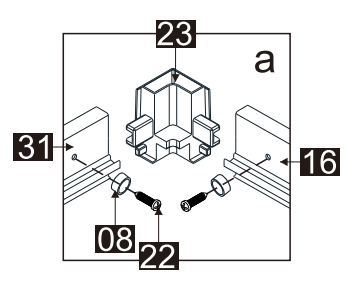

04

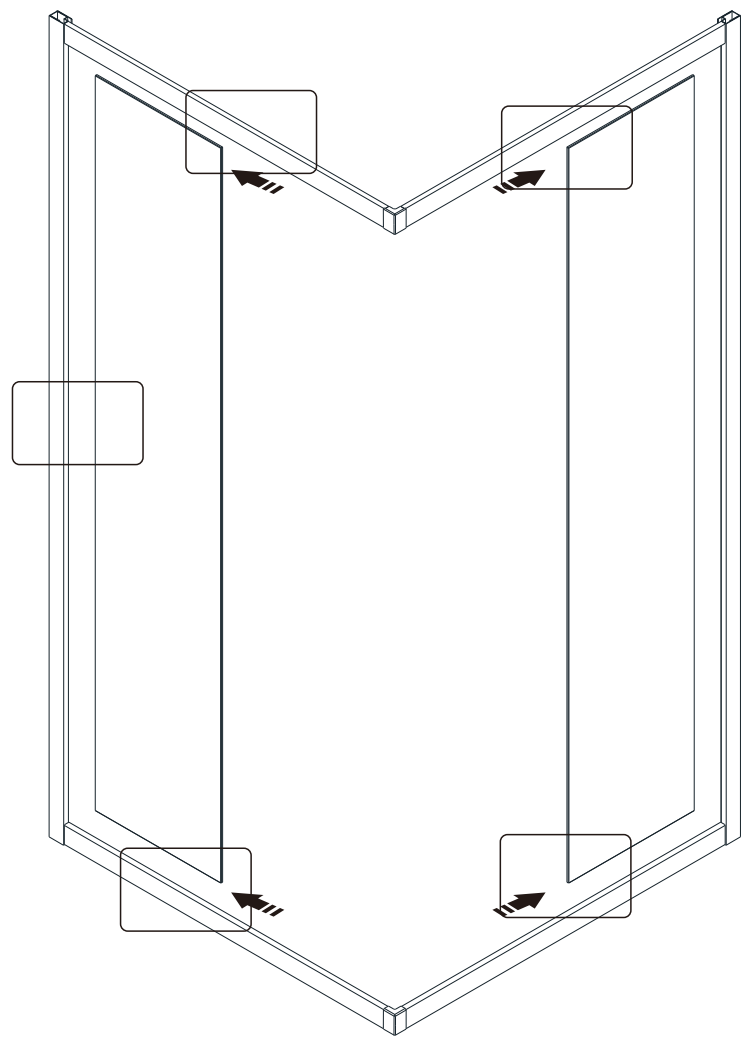
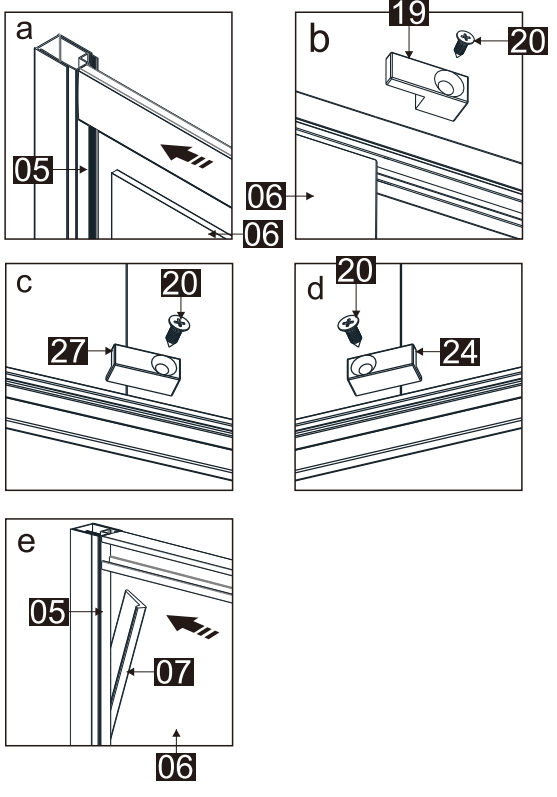

05

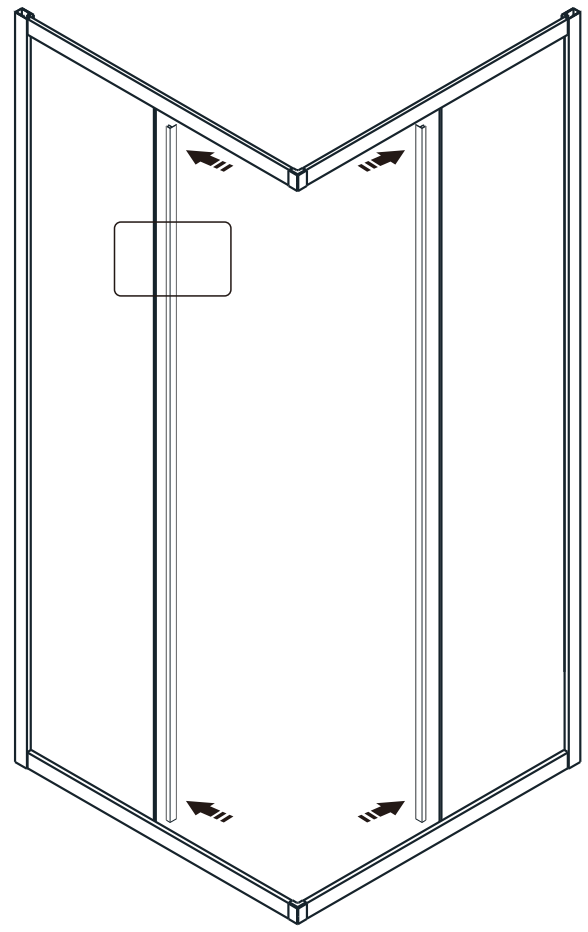
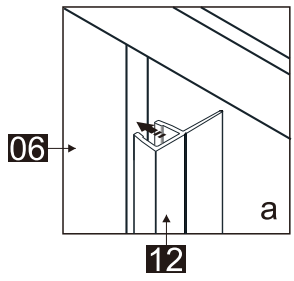

06

Caution:
 The handle is made of plastic
 1、 If an electric screwdriver is used, the torque shall not exceed 10 N;
 2、 If a manual screwdriver is used, do not over tighten;
 Otherwise the handle may be damaged.

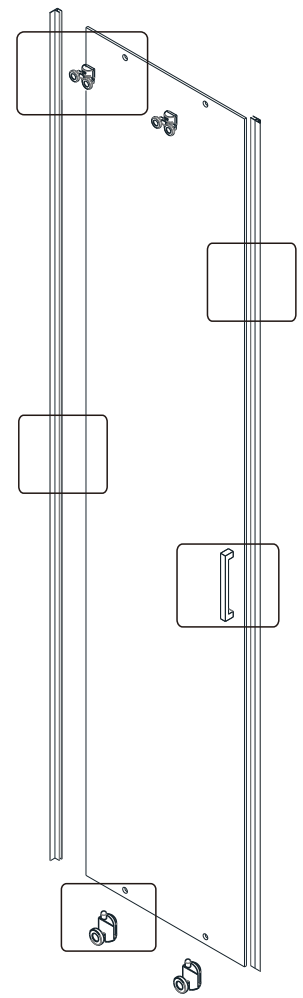
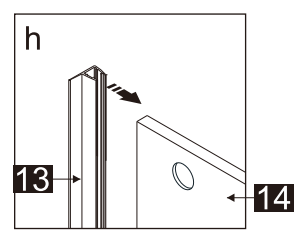
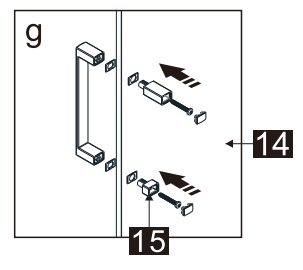
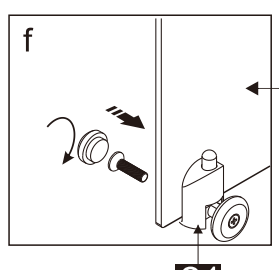
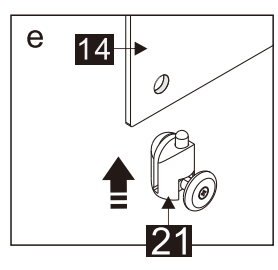
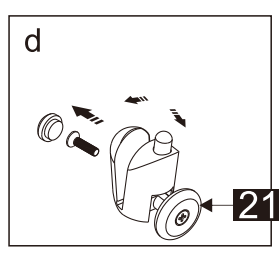
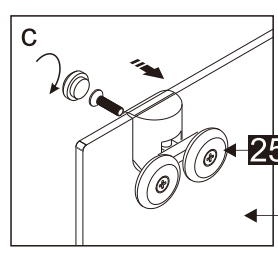
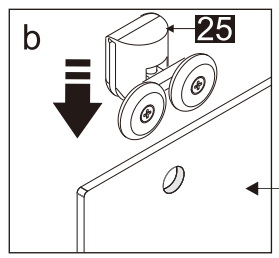
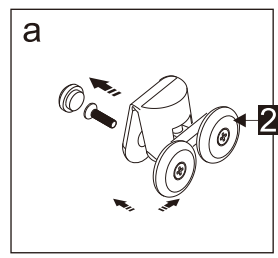

07

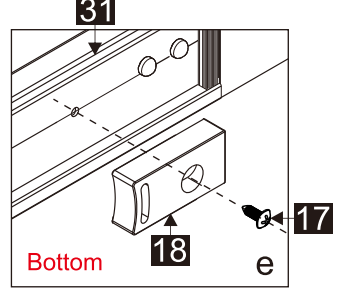
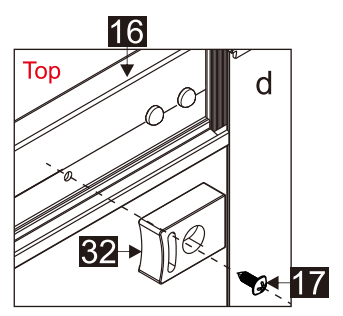
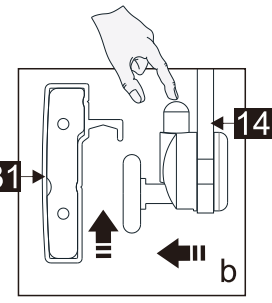
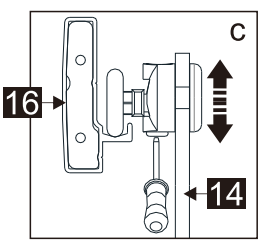
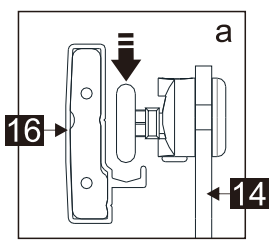
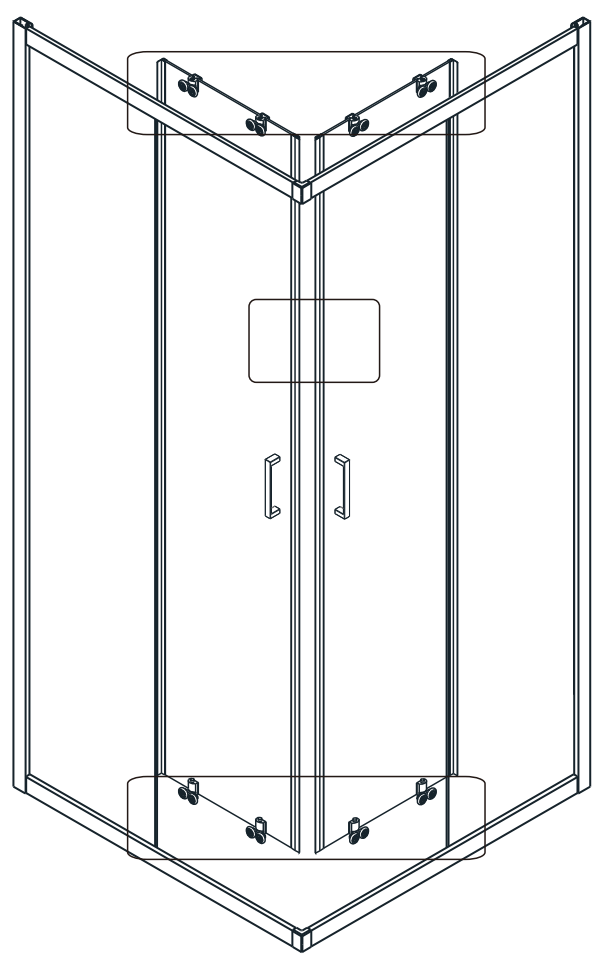
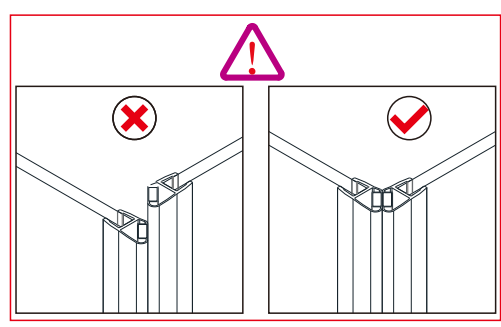

08

Drilling holes on the right to prevent the glass from being broken

Drilling holes on the left to prevent the glass from being too close to the edge of aluminum profile

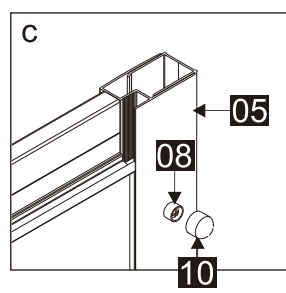
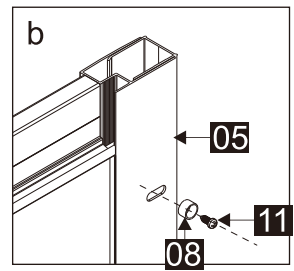
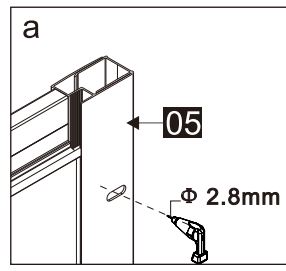
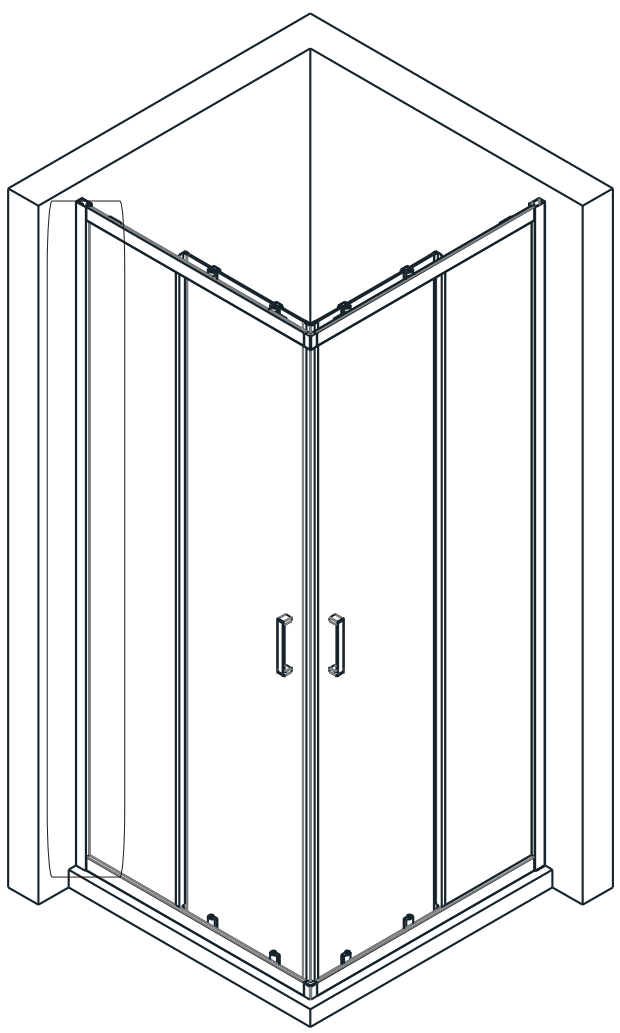
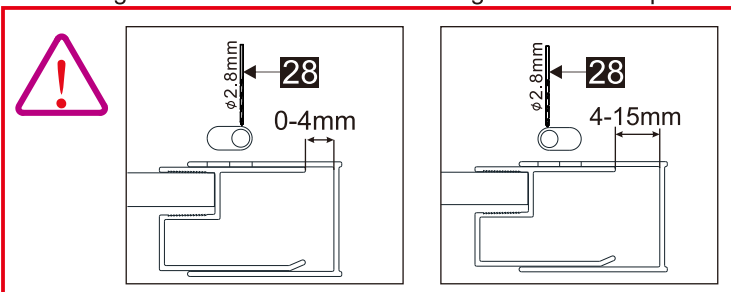

09

