

# Installation Manual

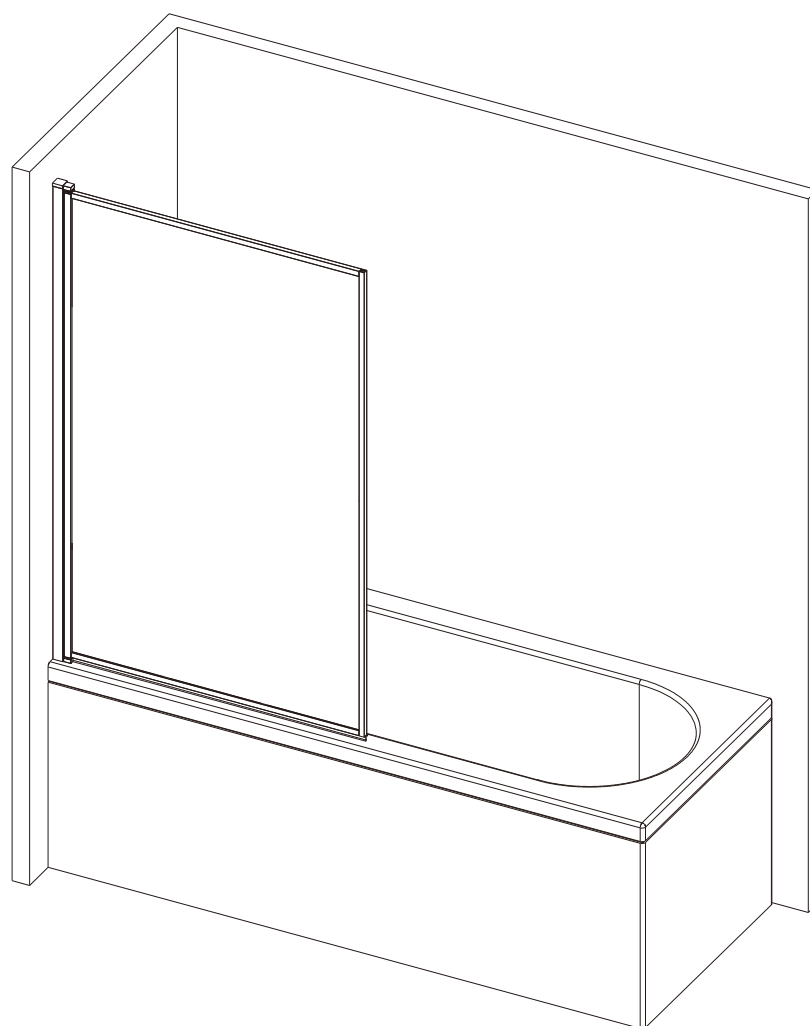

Apply for following models:

**55052/55053/55123/55195/55196**

Please keep this page for your online registration.

No. FIENSEB44V3.0



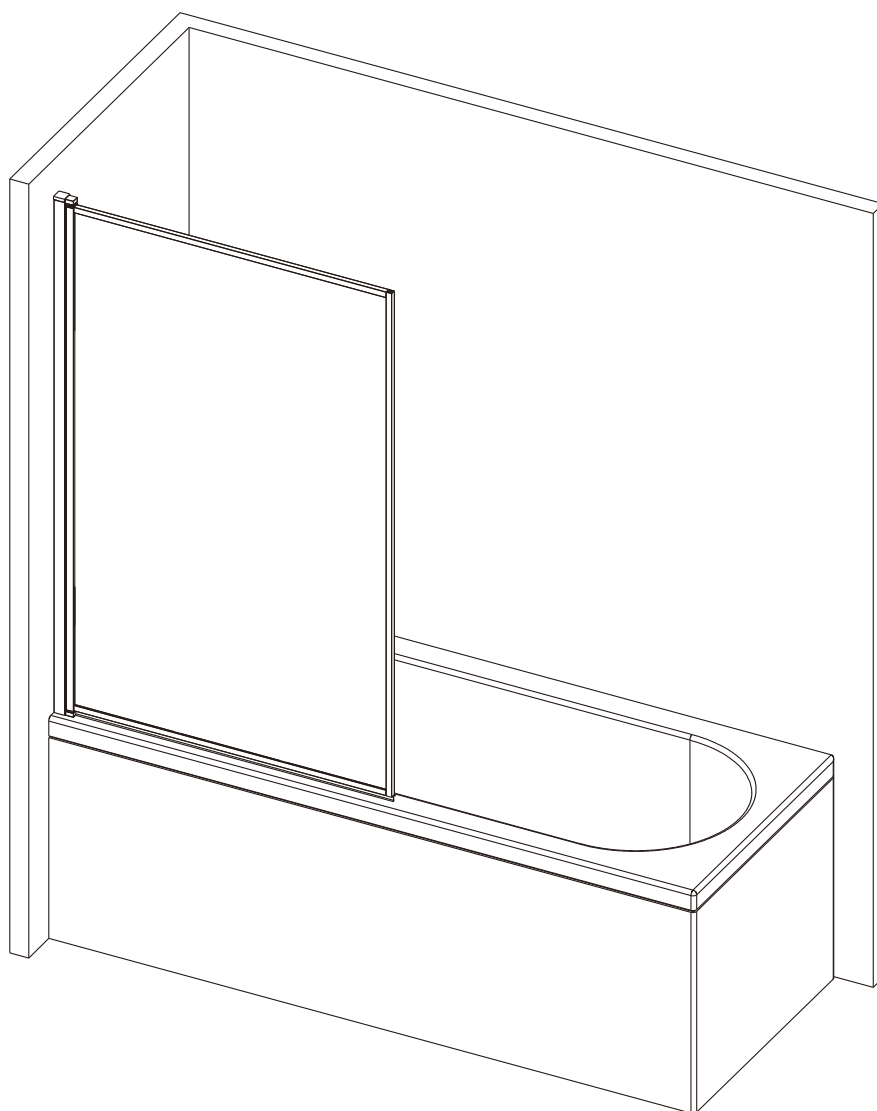



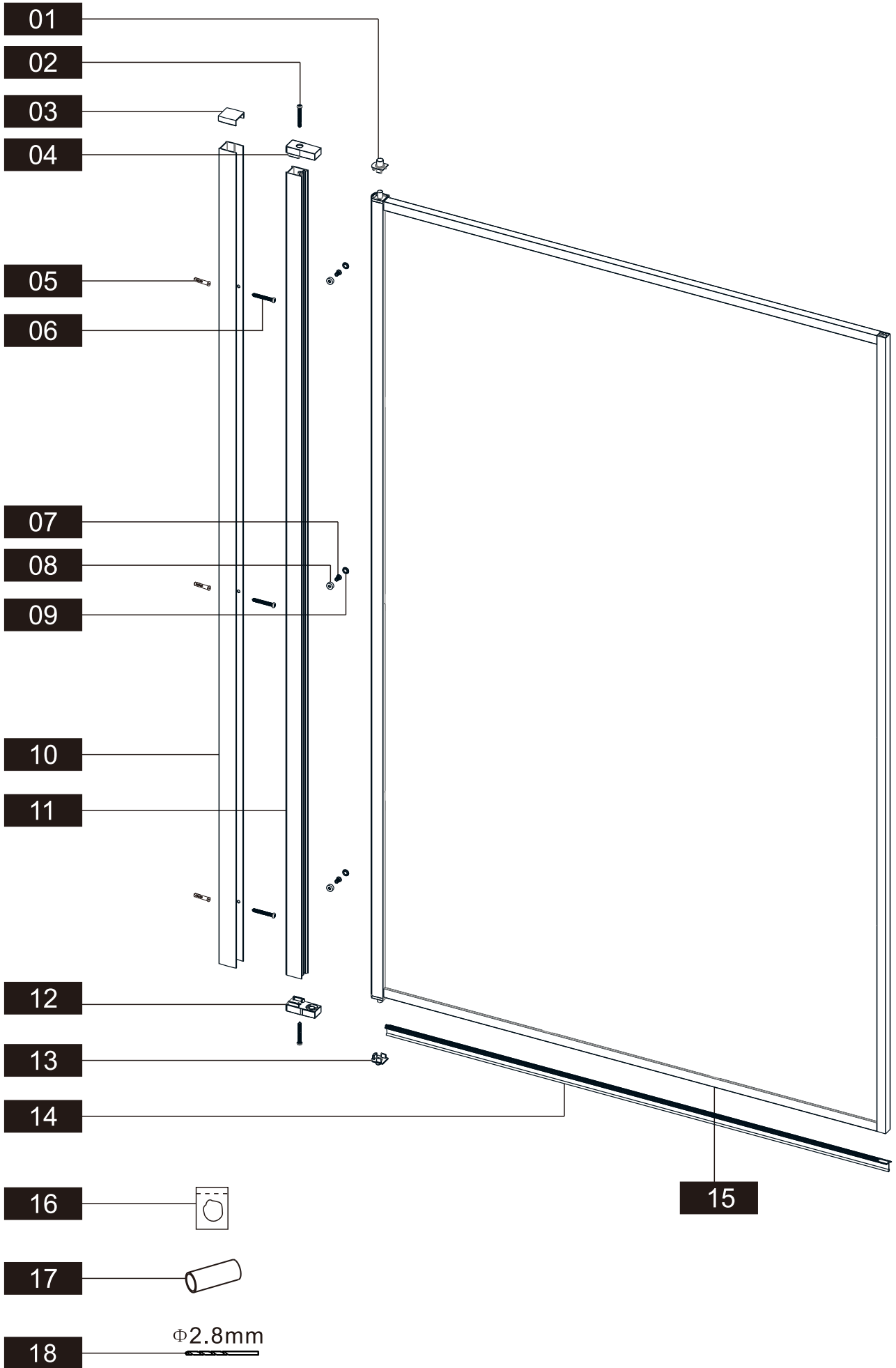















55052/55123/55195/55196	800
55053	1000



**Attention:** Before installation, please check whether the number and type of accessories are correct, and then install them. If there is any problem, please inform us as soon as possible. Thank you!

## Parts List

Part Number	Image	Size(mm)	Quantity	Remark
01			1	Top
02		ST3.5X30	2	
03			1	
04			1	Top
05			3	
06		ST4.0X35	3	
07		ST4.0X10	3	
08			3	
09			3	
10		1400	1	Aluminum profile
11		1378	1	Aluminum profile
12			1	Bottom
13			1	Bottom
14			1	Seal
15			1	
16			1	
17			1	
18		Φ2.8mm	1	

## You will need

To assemble your product (Tools not provided).

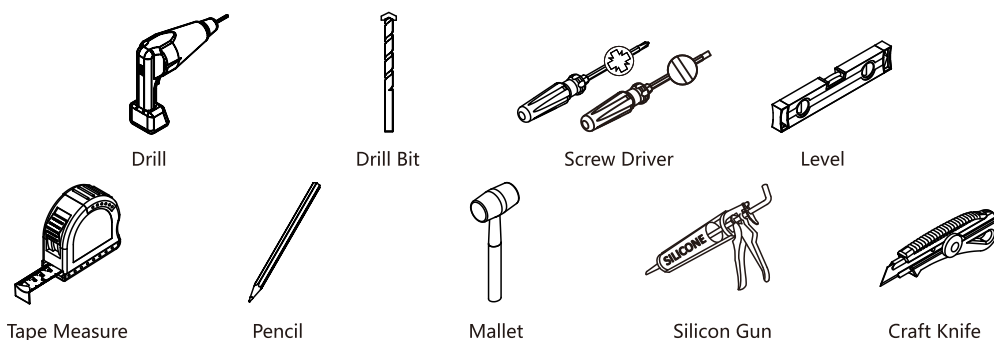

01

In this guide, this model is used to demonstrate the left opening

Ltem Code	A
55052/55123/55195/55196	787-800
55053	987-1000

Note:  
In consideration of the influence of walls and tiles, the actual installation size will be smaller than the size declared on the website, but it will not affect the normal usage. The adjustment shall be subject to the manual instructions.

