

# Installation Manual

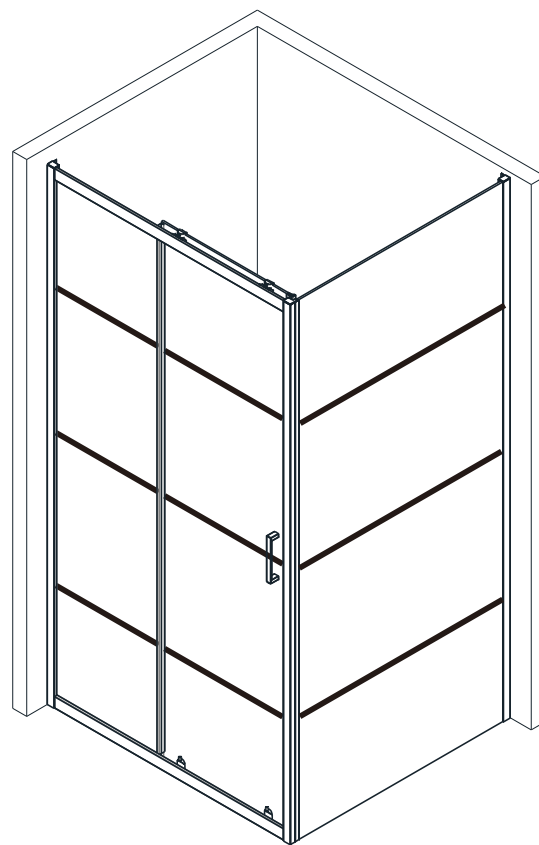
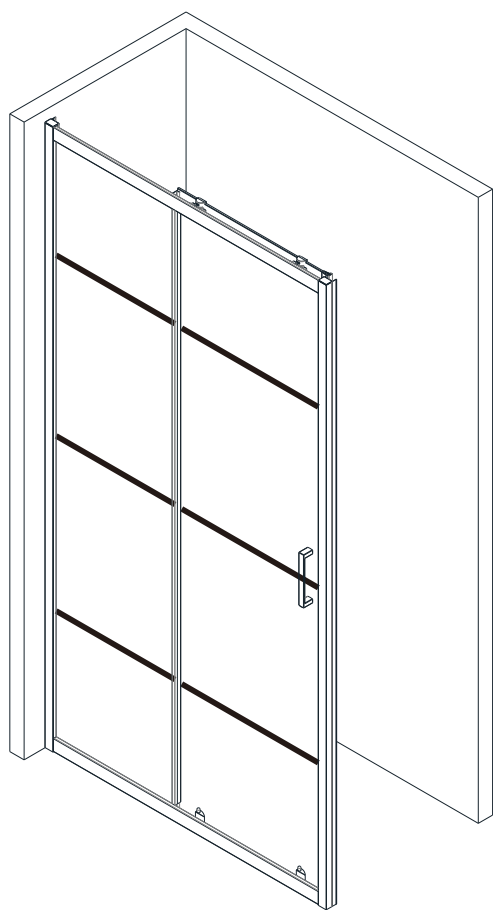

Apply for following models:

**41218/41219/41220/41221**  
**43067/43068/43069/43070**

Please keep this page for your online registration.

No. FIENSEB46V4.0



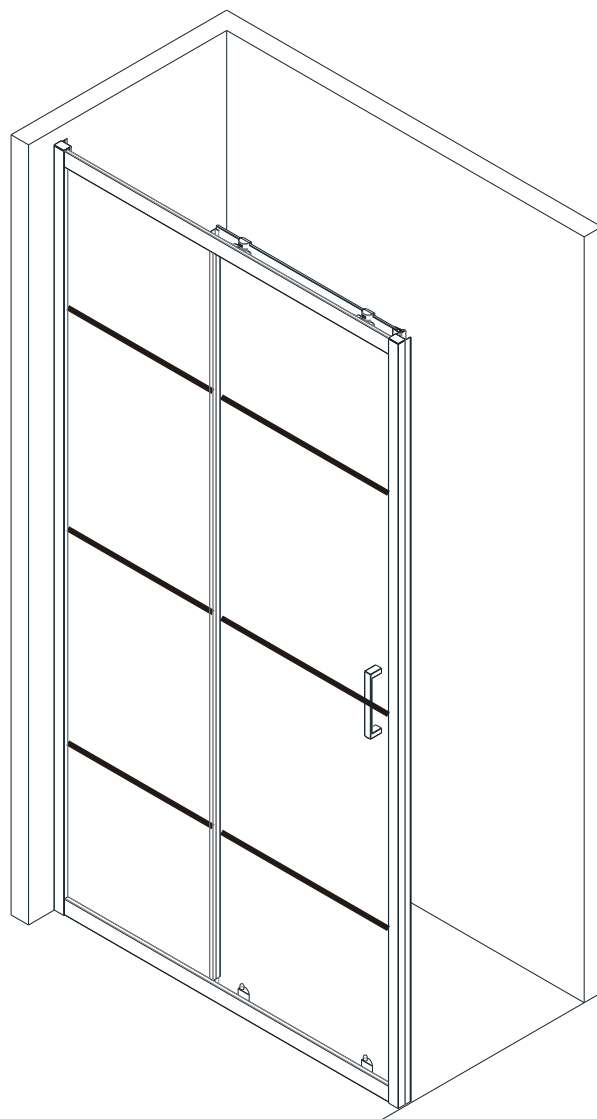

41218	1000
41219	1100
41220	1200
41221	1400

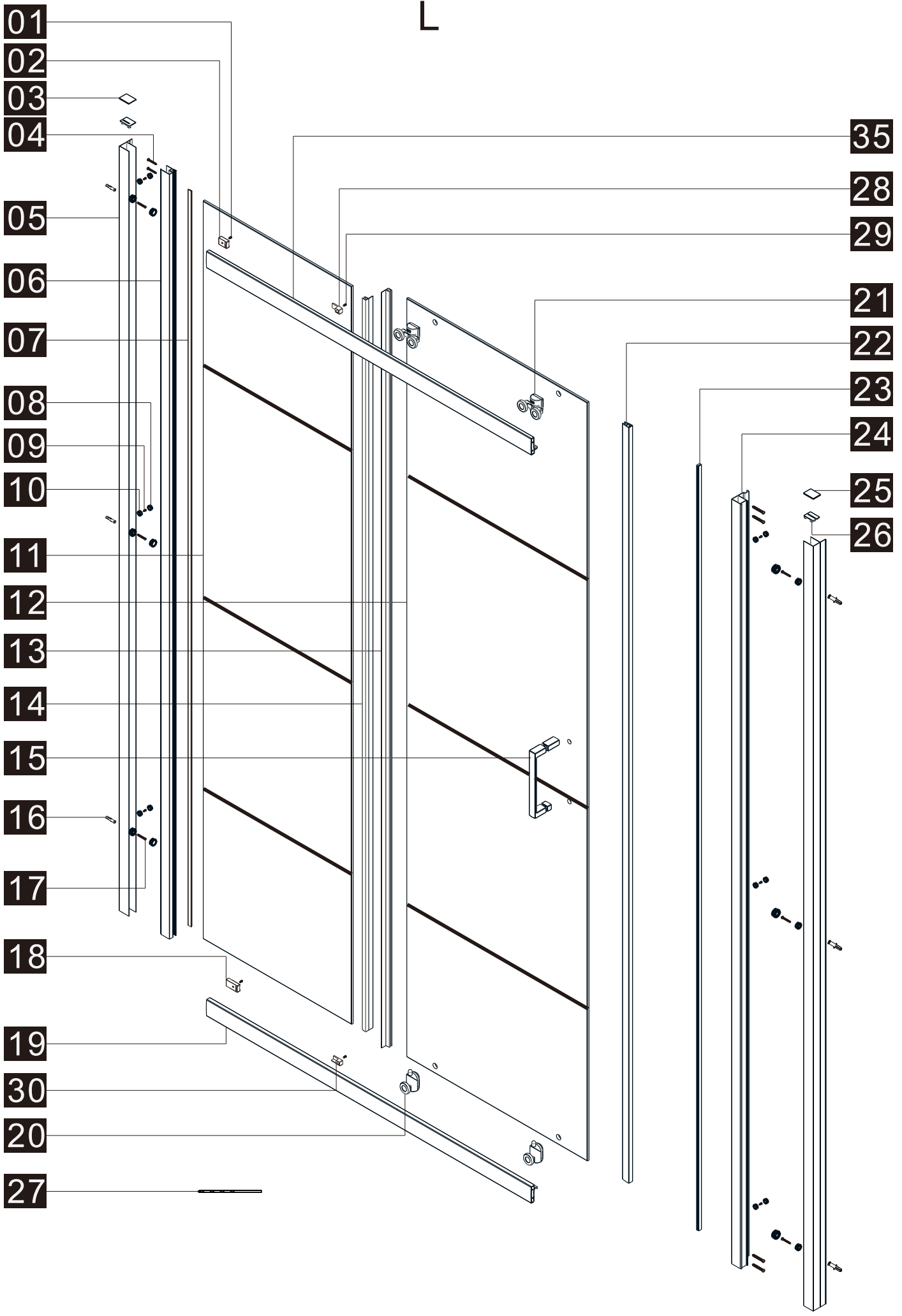





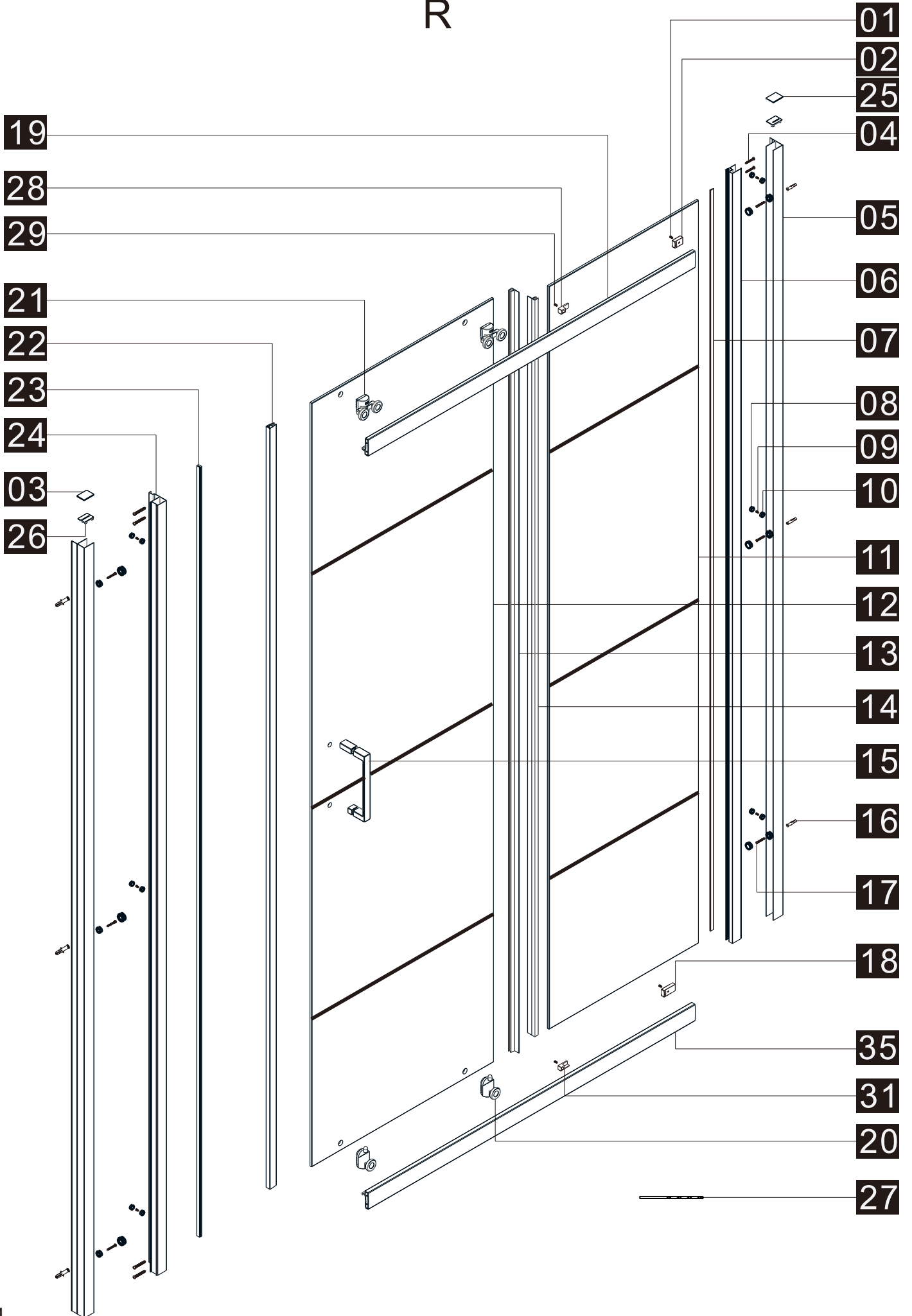







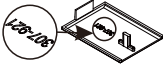









L

R



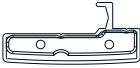

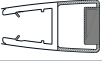



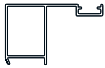
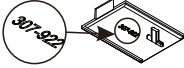

**Attention:** Before installation, please check whether the number and type of accessories are correct, and then install them. If there is any problem, please inform us as soon as possible. Thank you!

## Parts List

Part Number	Image	Size(mm)	Quantity	Remark
01		ST4X10	2	
02			1	Short
03			1	L side
04		ST3.5X30	8	
05		1850	2	Aluminum profile
06		1850	1	Aluminum profile
07		1786	1	Seal
08			12	
09		ST4X10	6	
10			12	
11			1	
12			1	
13		1830	1	Seal
14		1770	1	Seal
15			1	
16			6	
17		ST4X35	6	
18			1	Long
19			1	Aluminum profile
20			2	
21			2	
22		1830	1	Magnetic seal
23		1850	1	Magnetic seal

## Parts List

Part Number	Image	Size(mm)	Quantity	Remark
24		1850	1	Aluminum profile
25			1	R side
26			2	
27		∅2.8mm	1	
28			1	
29		ST4X14	2	
30			1	L side
31			1	R side
35			1	Aluminum profile

## You will need

To assemble your product (Tools not provided).

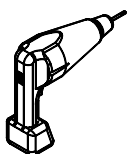

Drill



Drill Bit

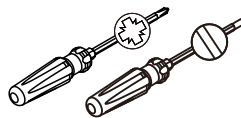

Screw Driver

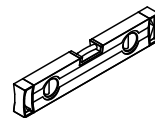

Level

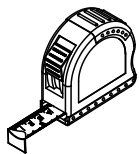

Tape Measure



Pencil

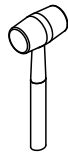

Mallet



Silicon Gun

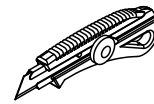

Craft Knife

L

32

26

33

08

09



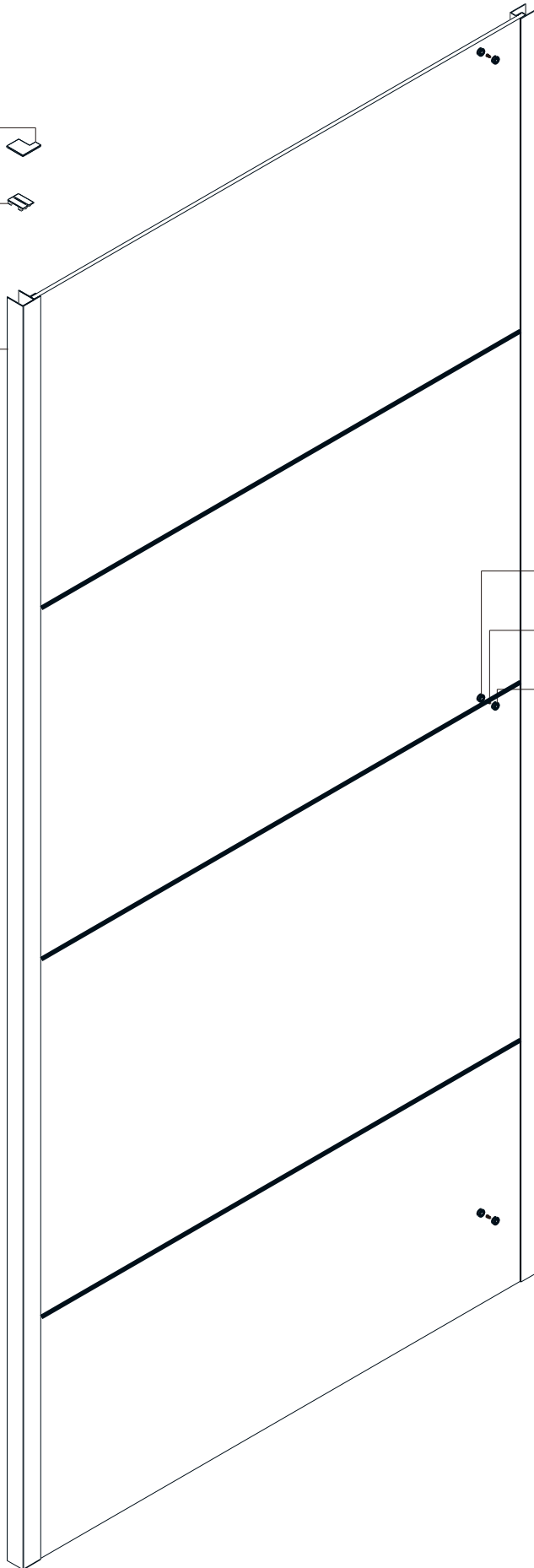

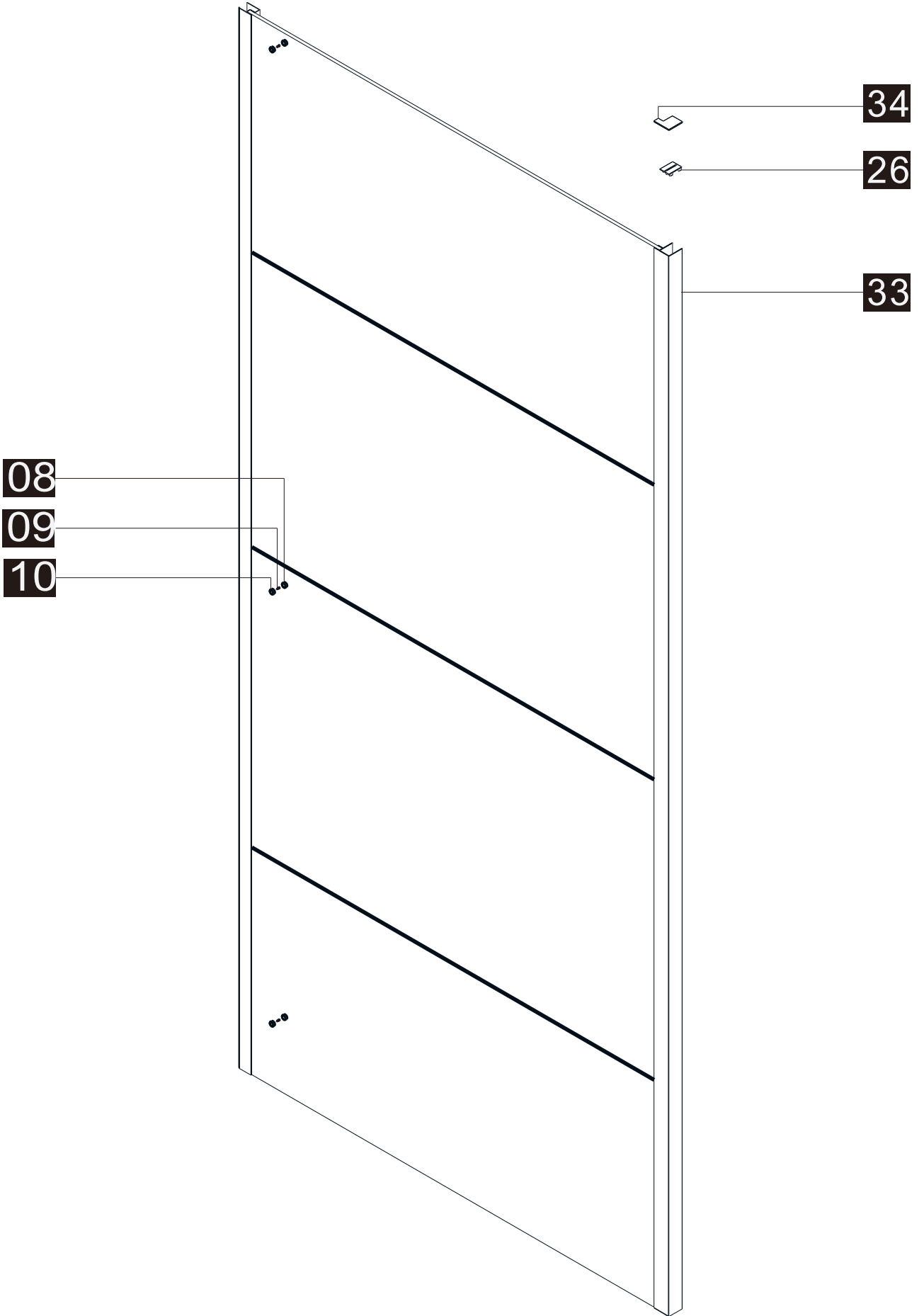

10



R



## Parts List

Part Number	Image	Size(mm)	Quantity	Remark
32			1	L side
33			1	
26			1	
08			3	
09		ST4X10	3	
10			3	
34			1	R side

## You will need

To assemble your product (Tools not provided).

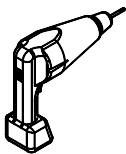

Drill



Drill Bit

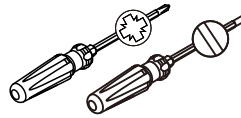

Screw Driver

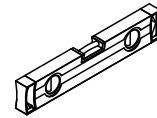

Level

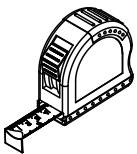

Tape Measure



Pencil

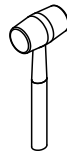

Mallet



Silicon Gun

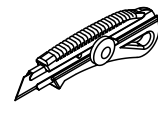

Craft Knife

01

In this guide, this model is used to demonstrate the left opening

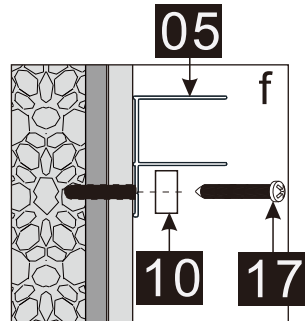
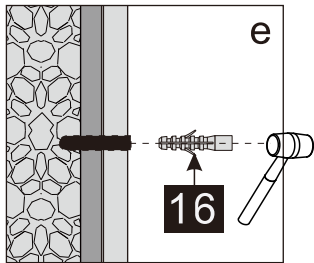
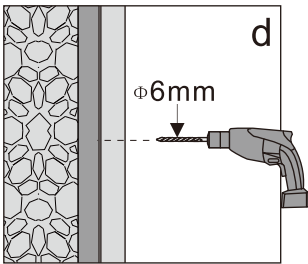
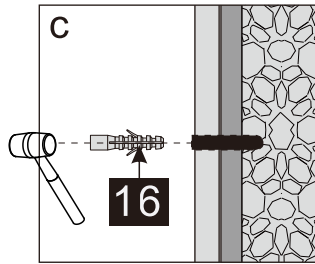
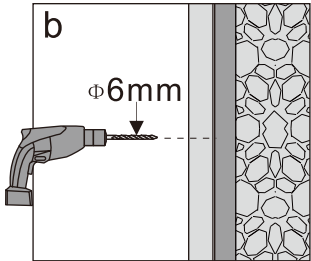
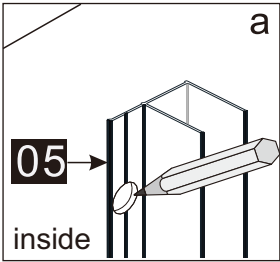
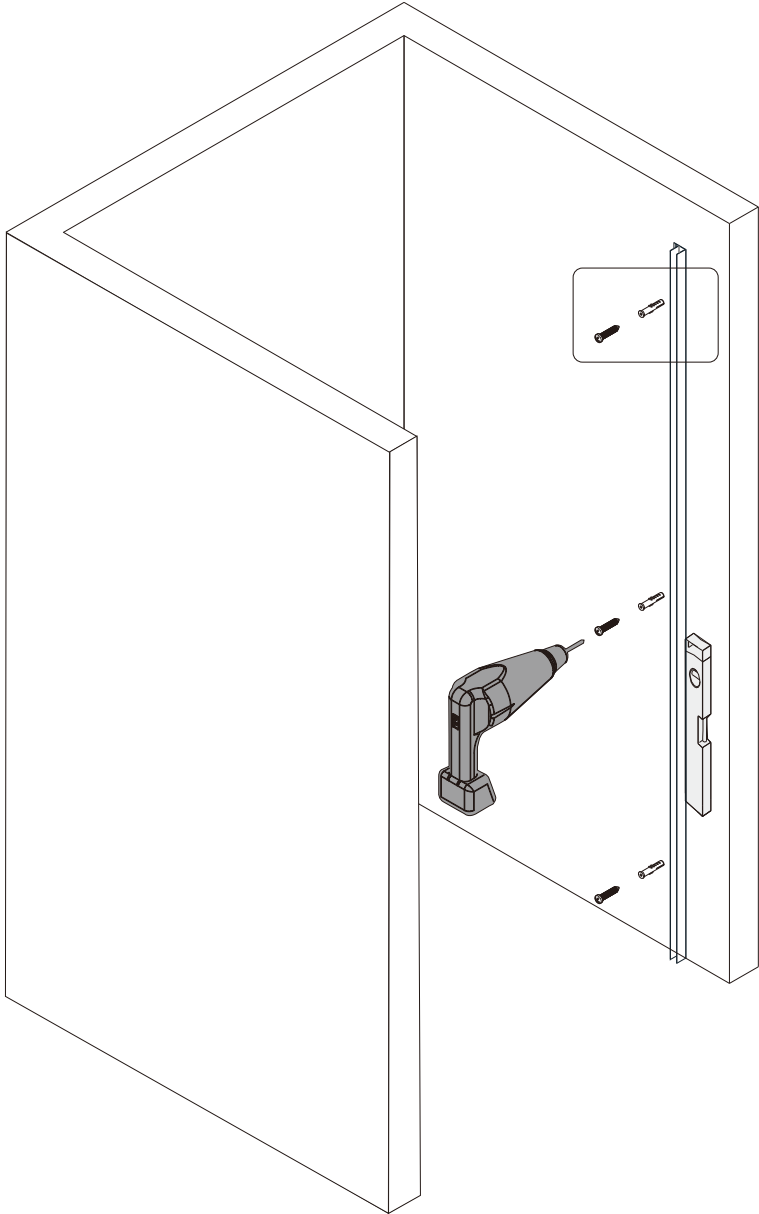

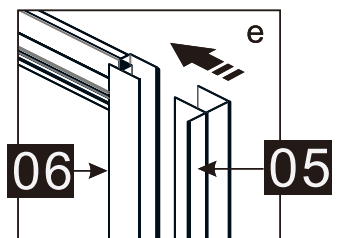
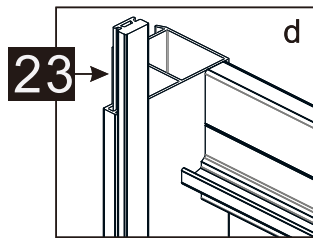
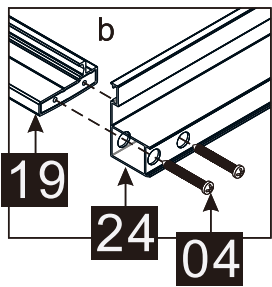
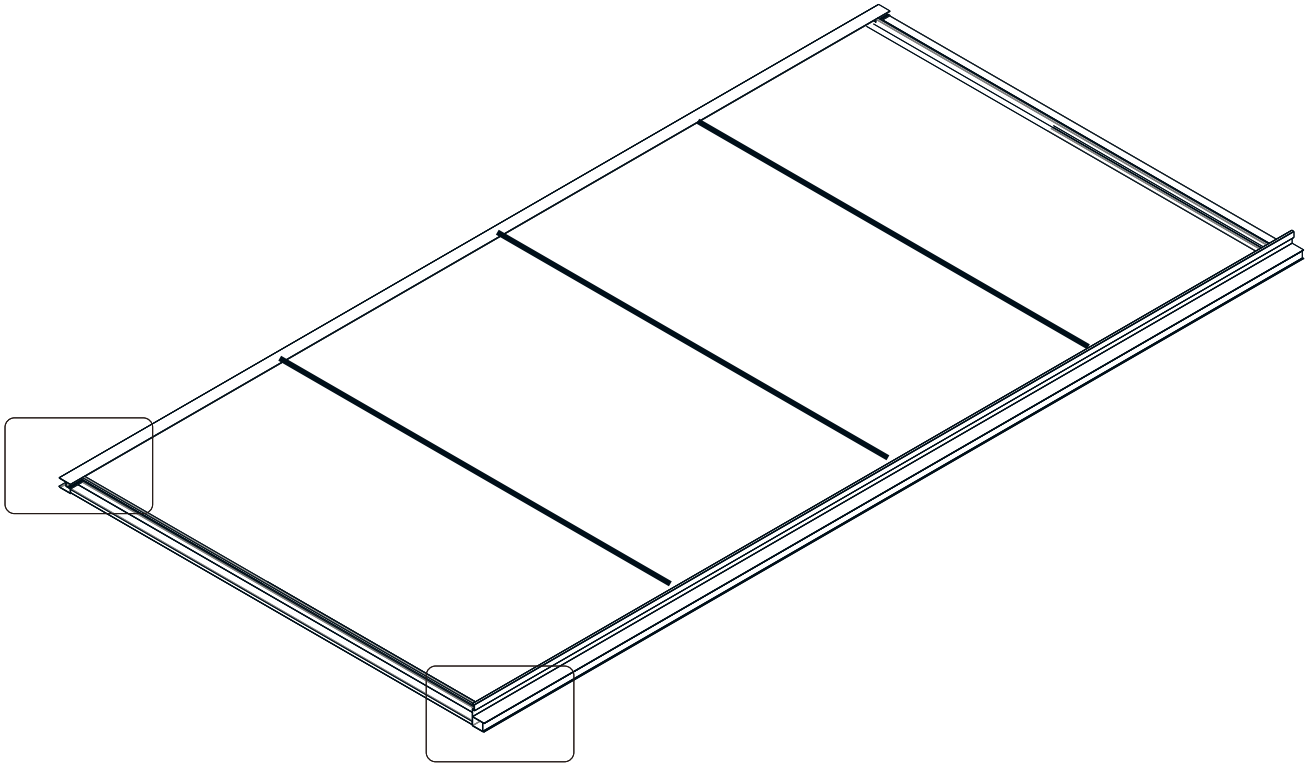
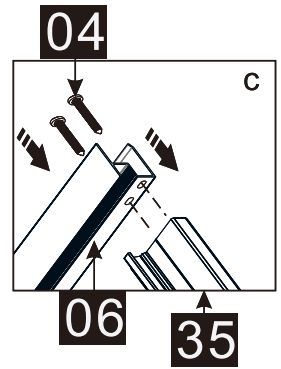
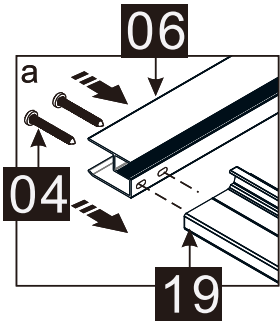

03

Note: If it is black stripe glass, the glass must be installed vertically in the direction of the upward label

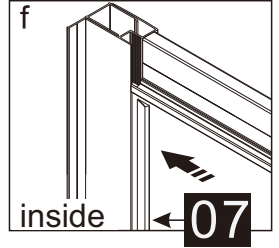
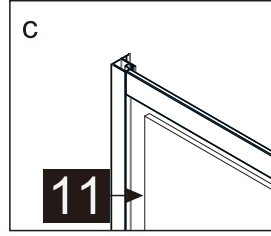
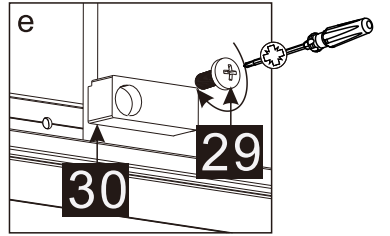
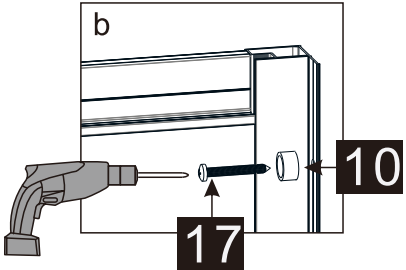
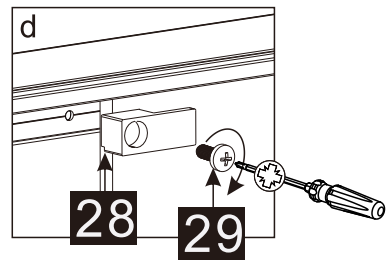
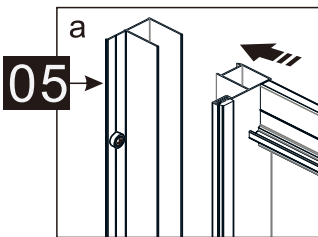
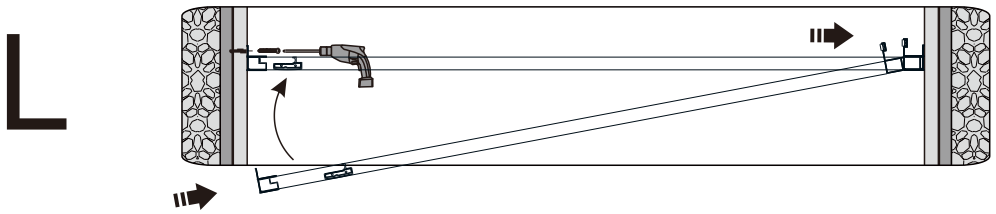
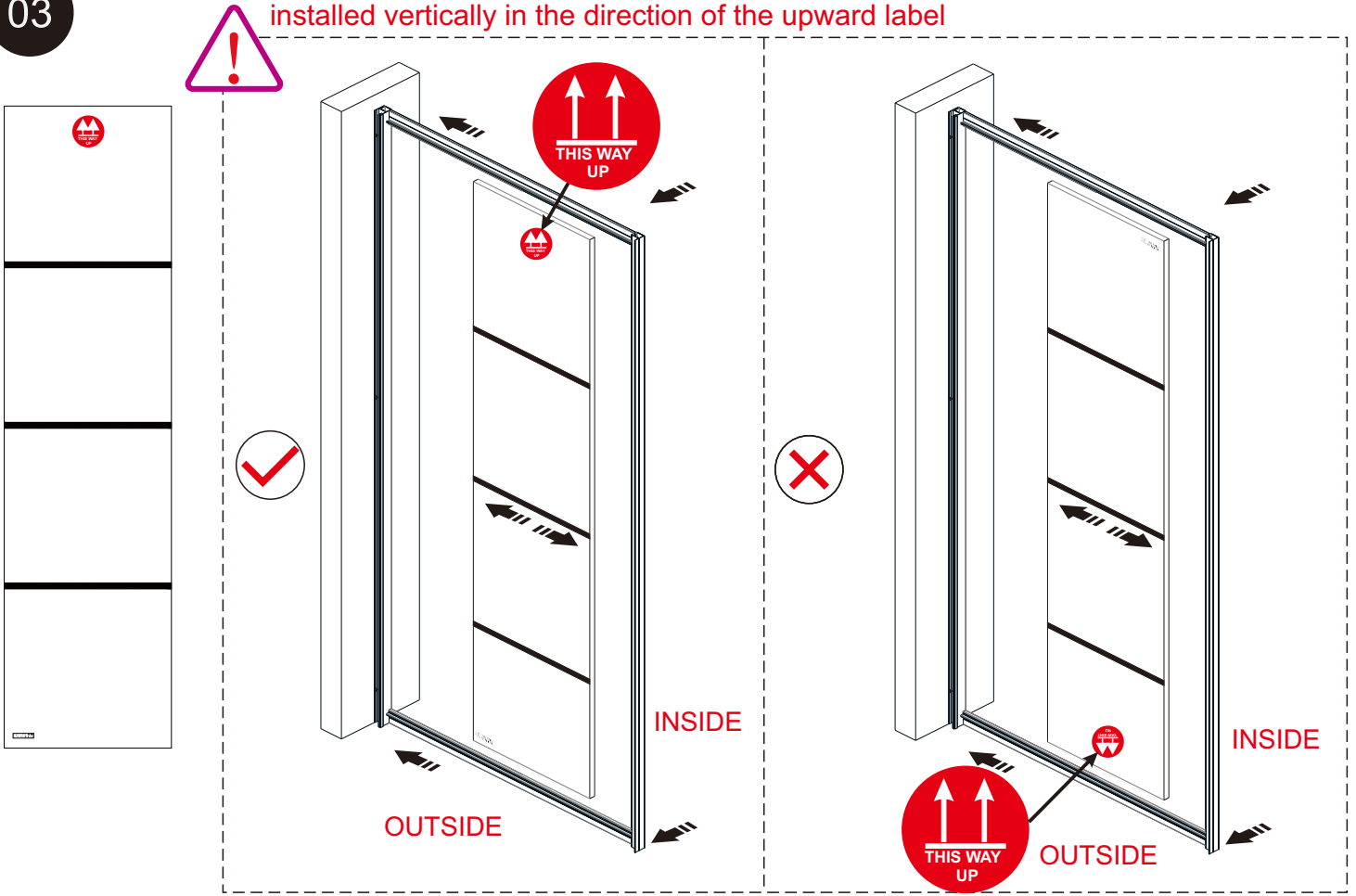

03

Note: If it is black stripe glass, the glass must be installed vertically in the direction of the upward label

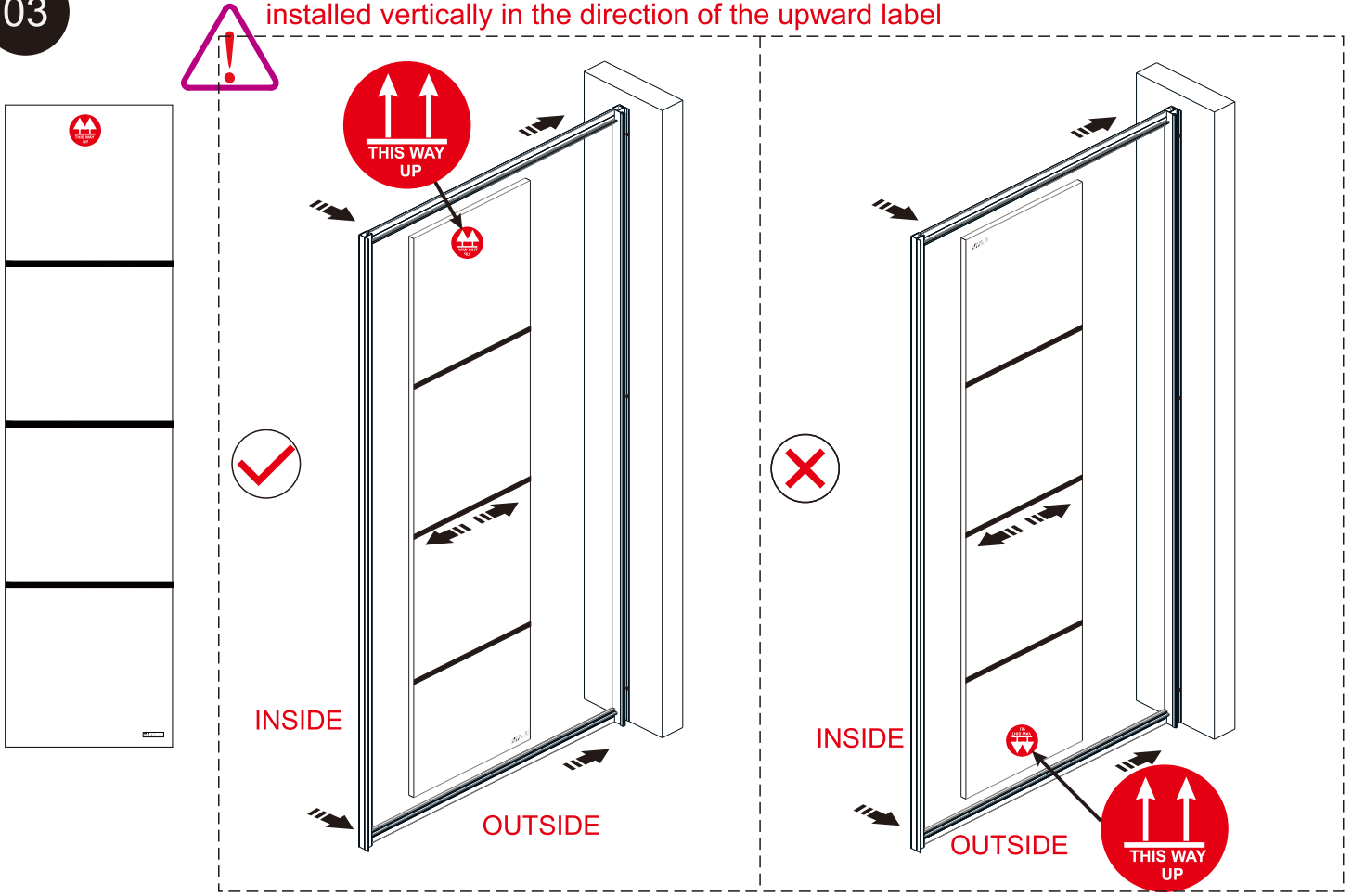

R

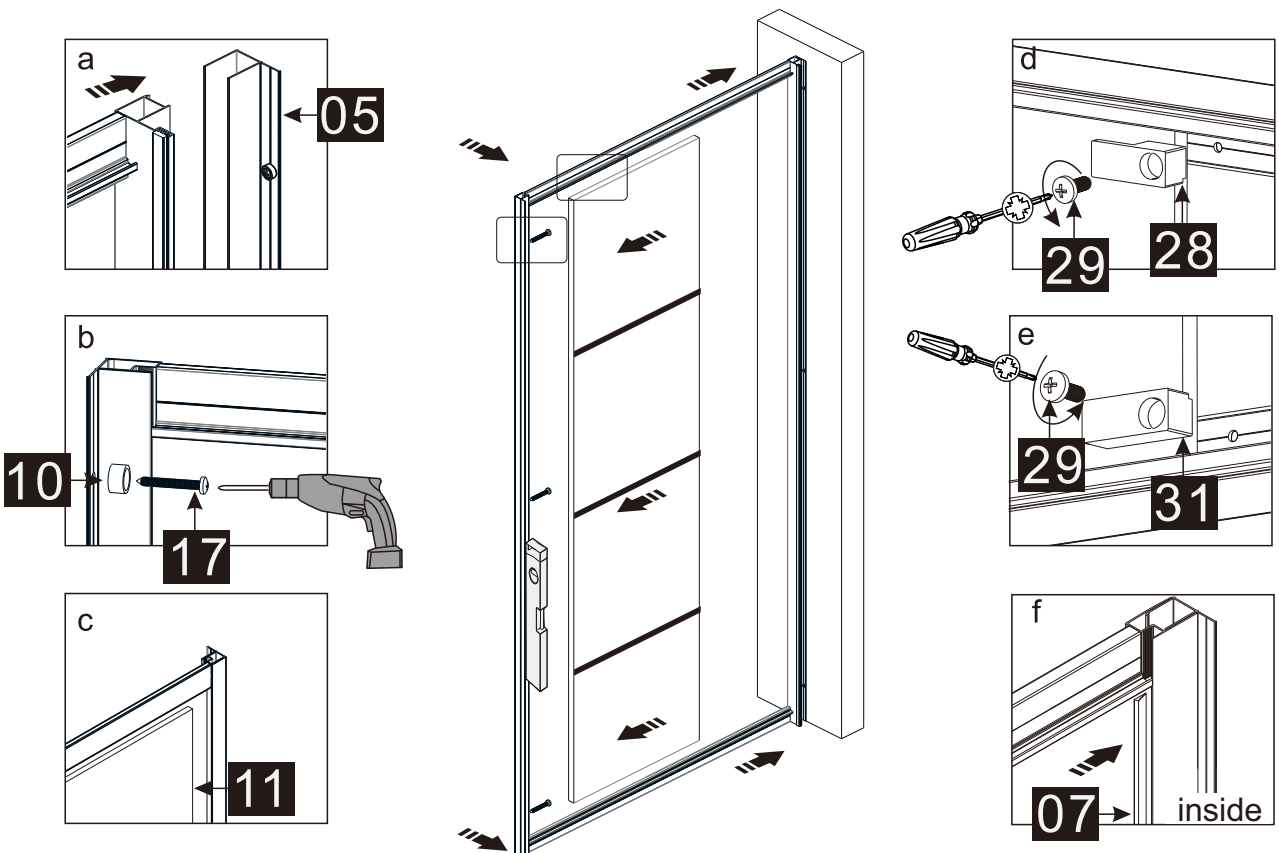
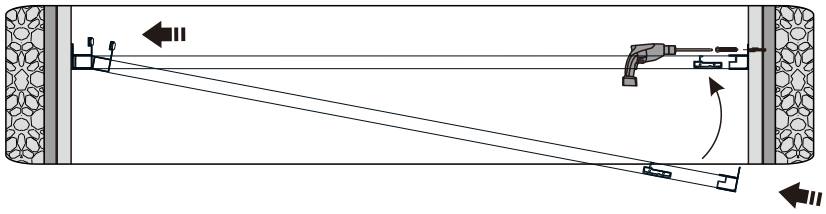

04

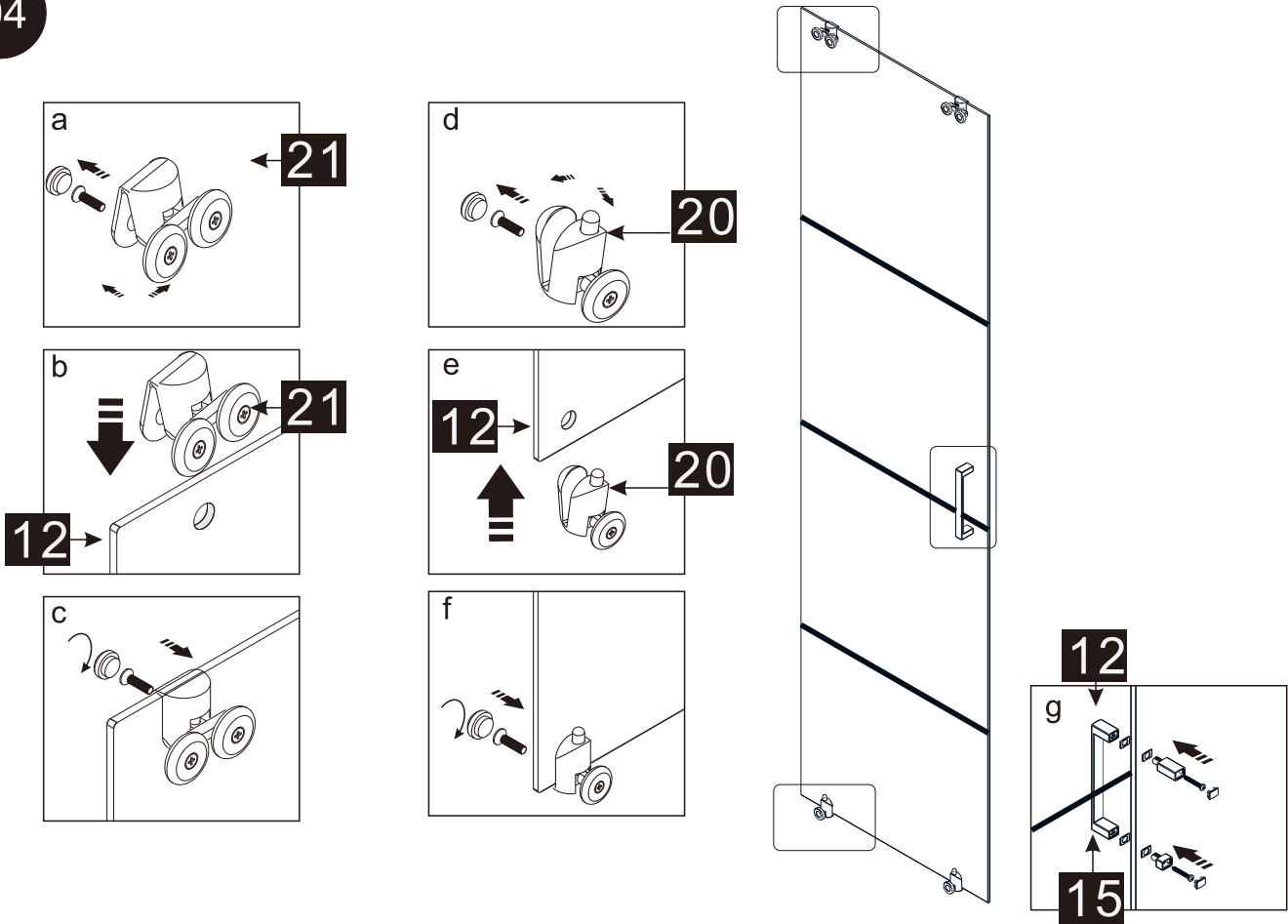

05

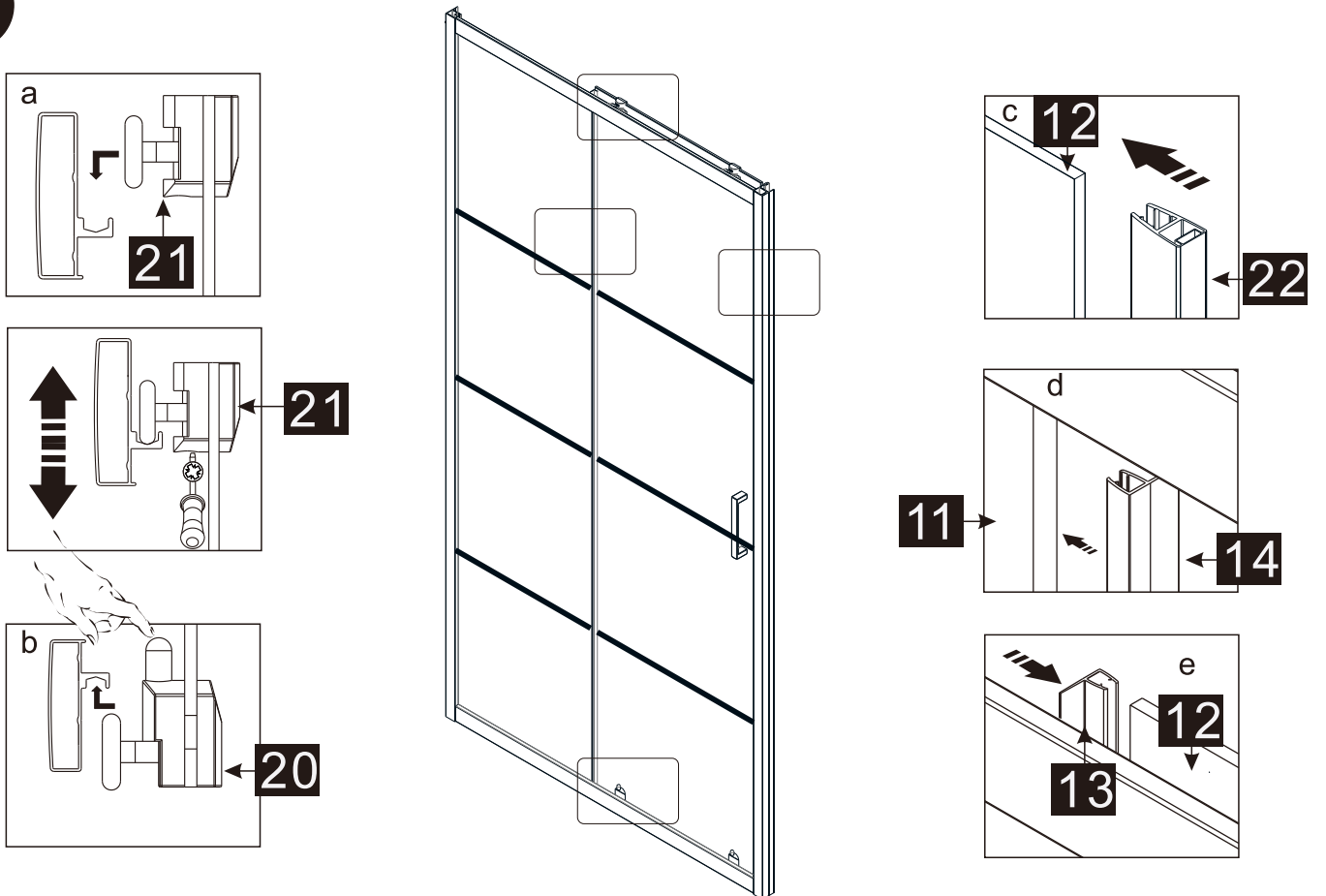

06

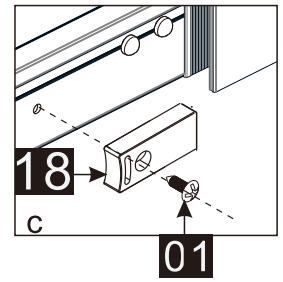
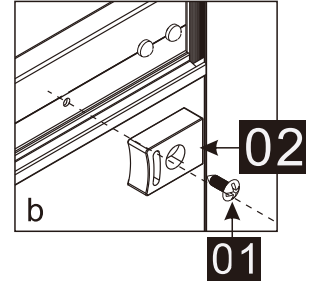
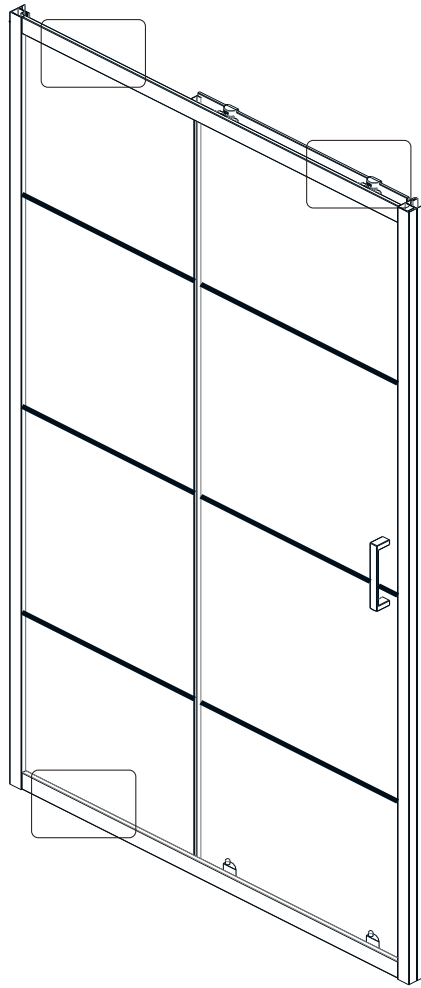
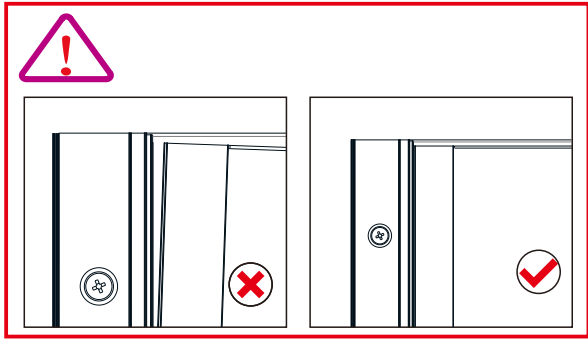
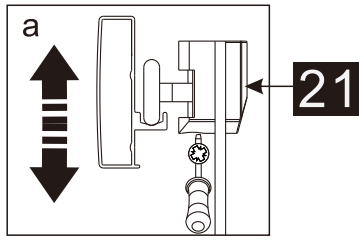

07

Drilling holes on the right to prevent the glass from being broken

Drilling holes on the left to prevent the glass from being too close to the edge of aluminum profile

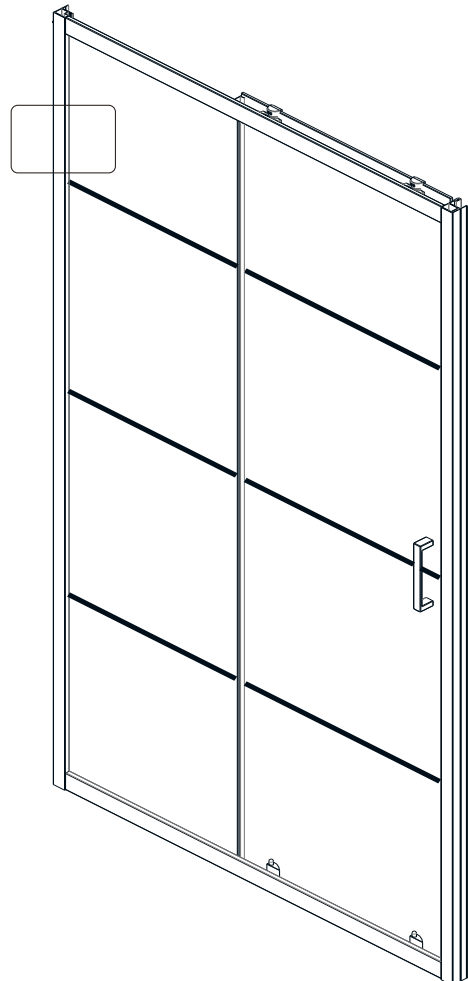
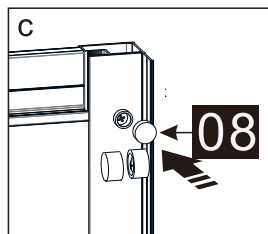
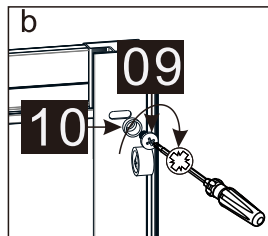
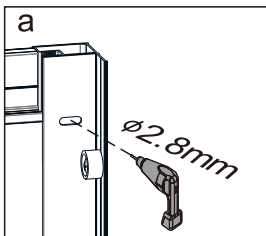
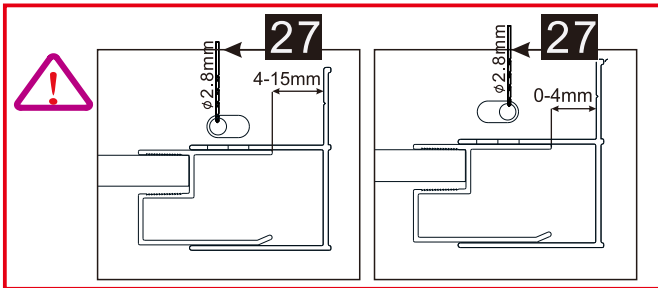

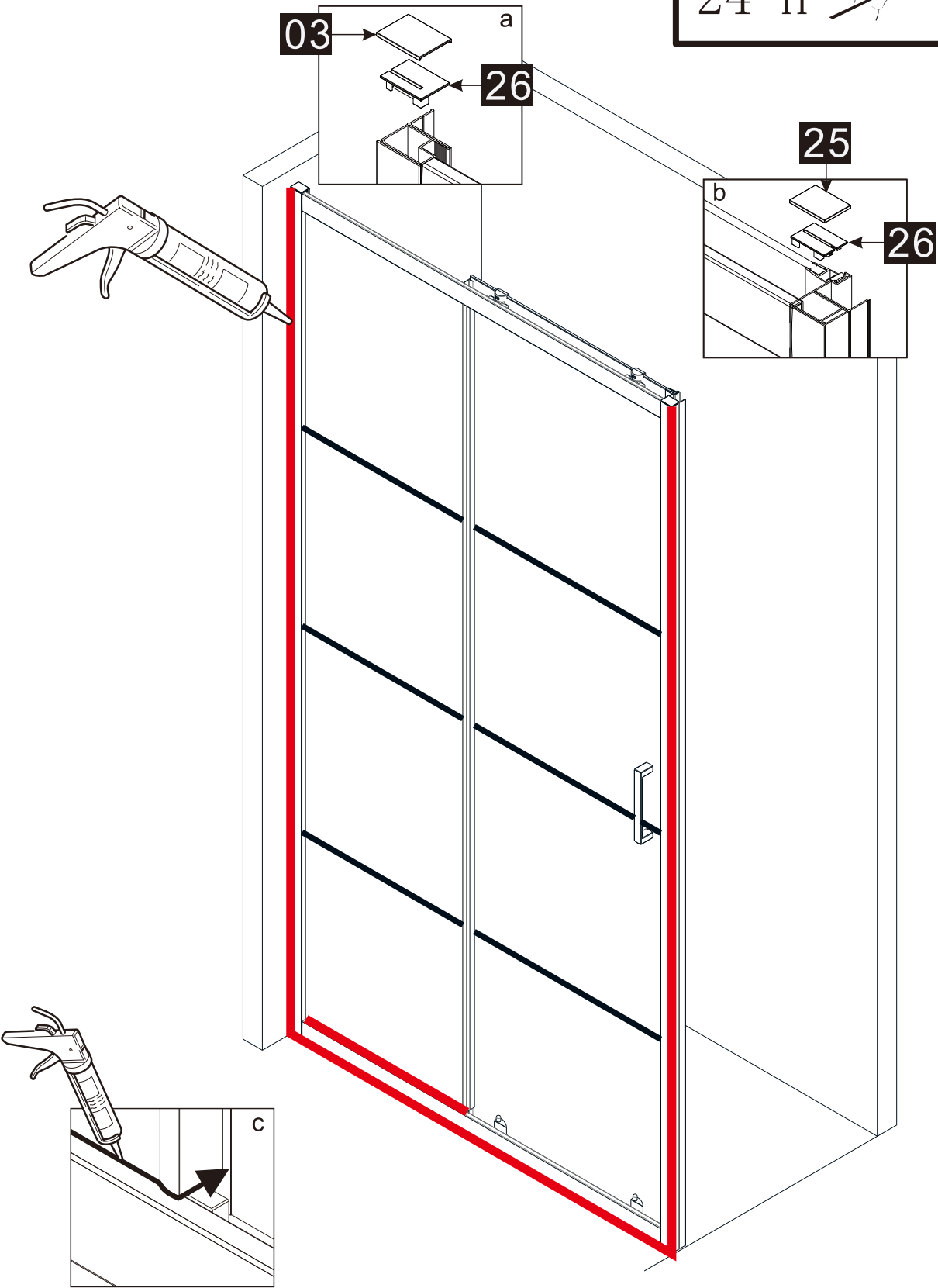

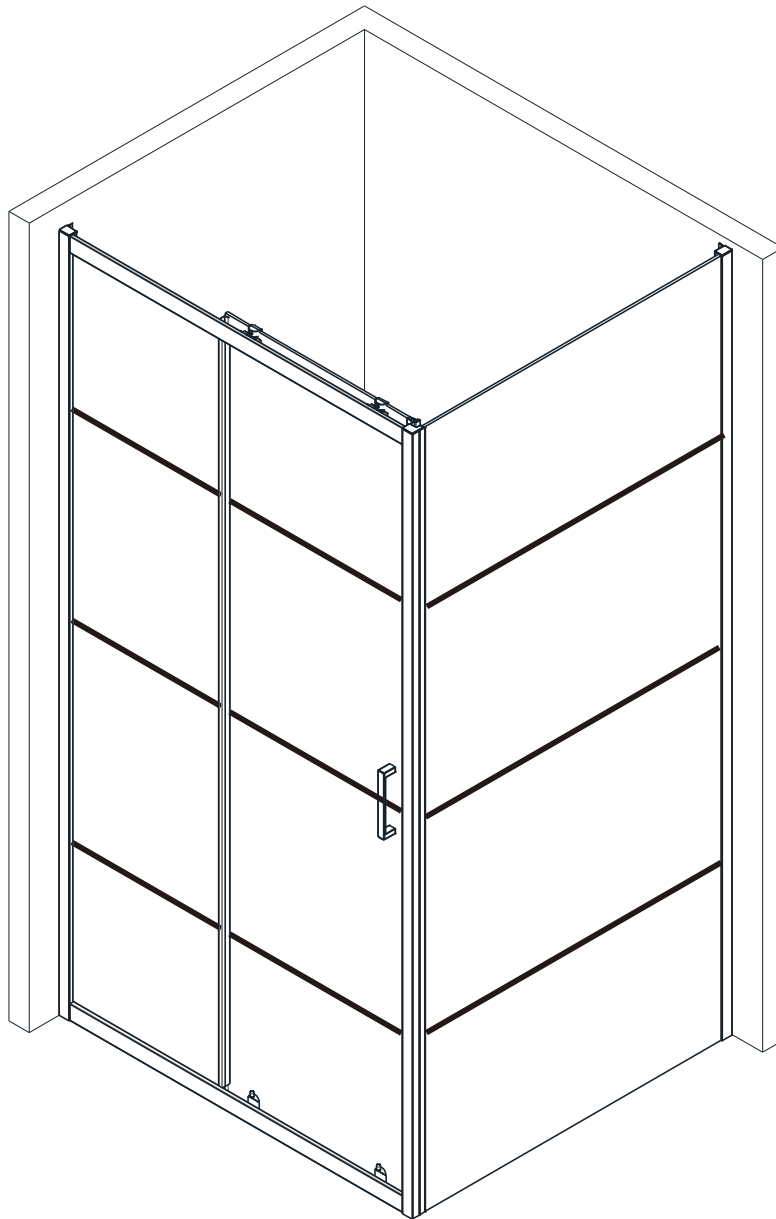

41218	1000
41219	1100
41220	1200
41221	1400

+

43067	700
43068	760
43069	800
43070	900

In this guide, this model is used to demonstrate the left opening

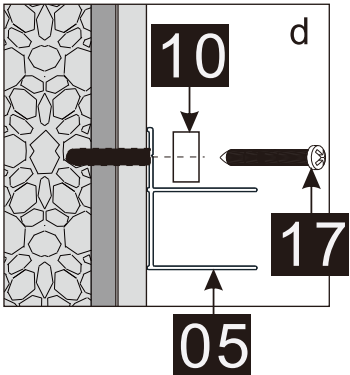
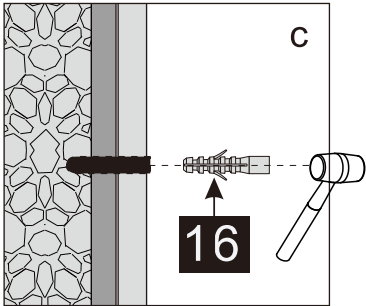
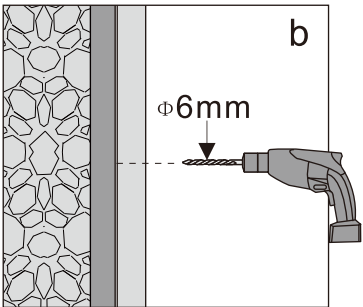
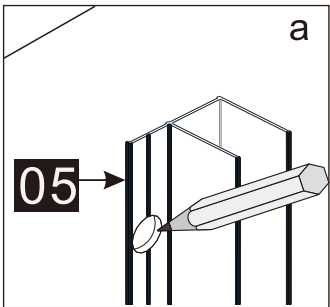
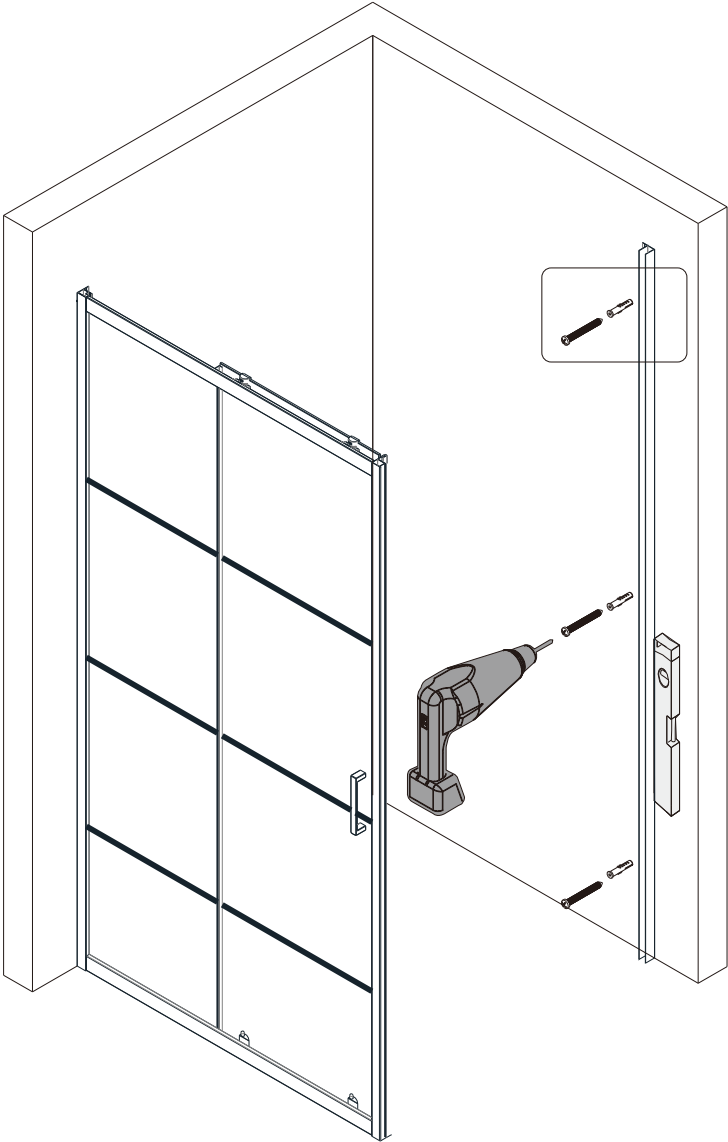

10

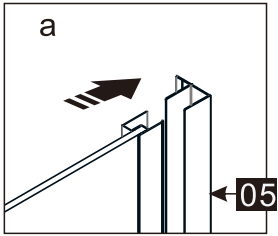
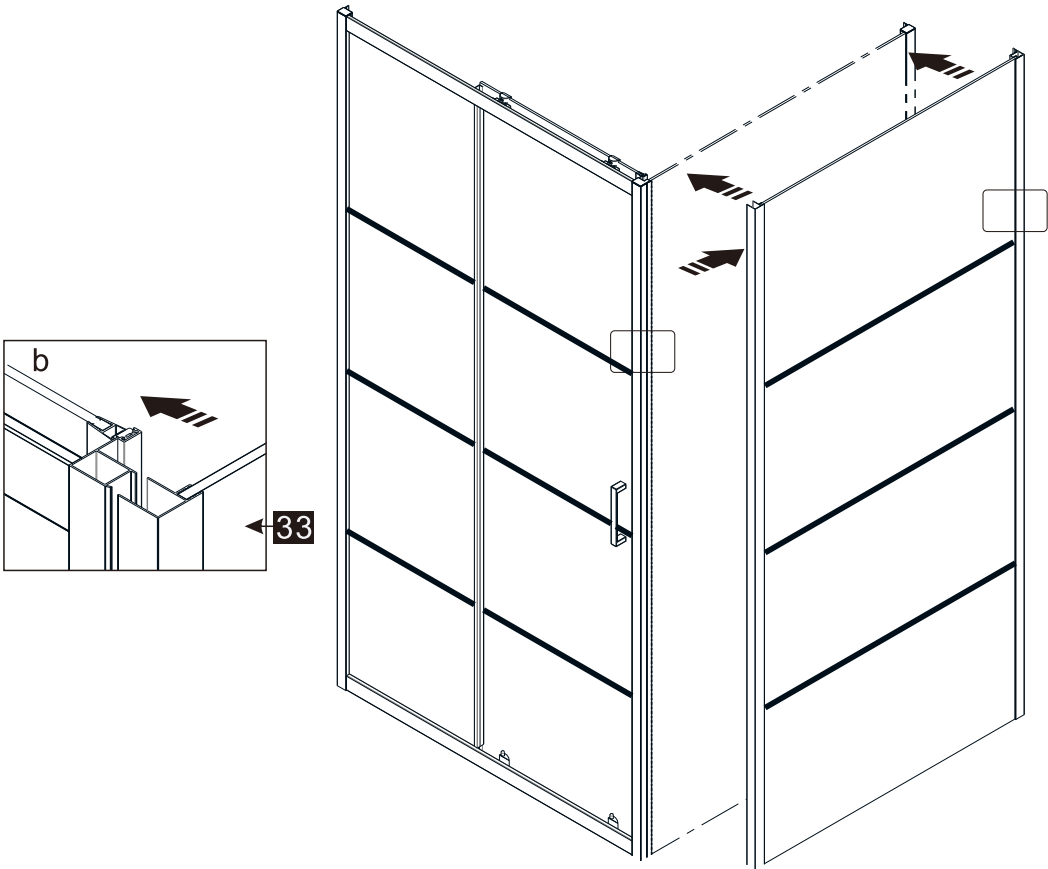

11

Drilling holes on the right to prevent the glass from being broken

Drilling holes on the left to prevent the glass from being too close to the edge of aluminum profile

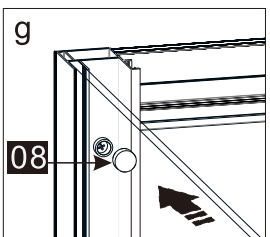
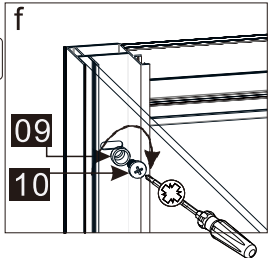
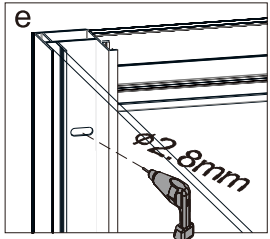
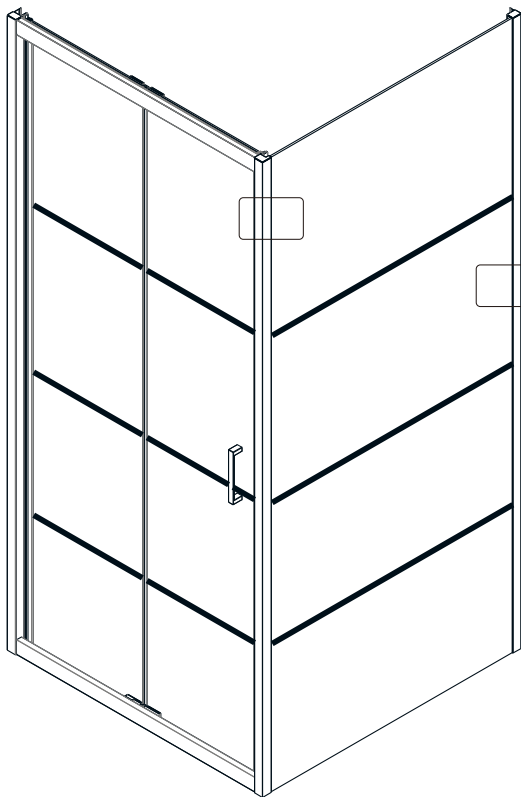
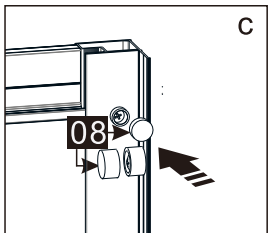
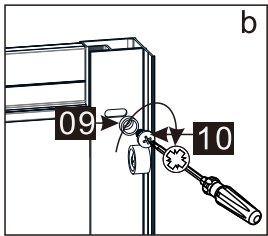
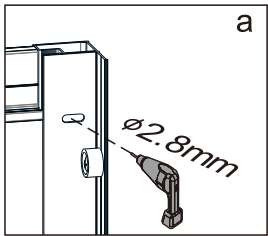
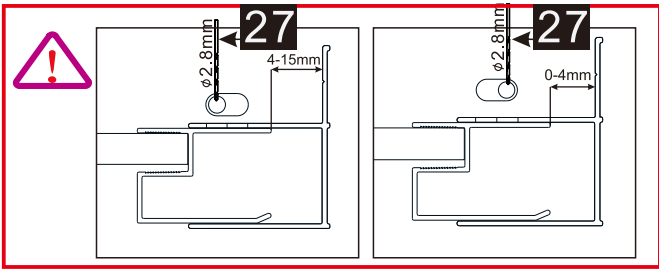

12

