

LED Square Backlight Mirror

INSTALLATION MANUAL

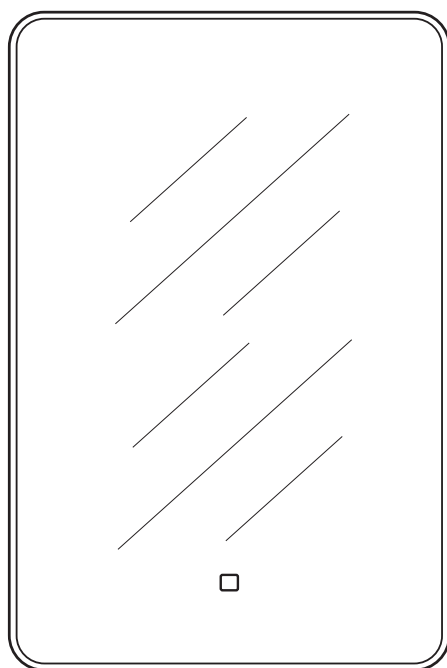

ACCESSORIES LIST

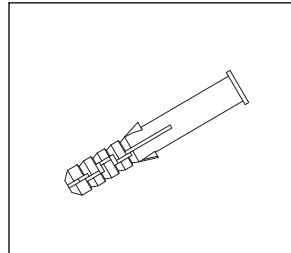

Expansion Screw

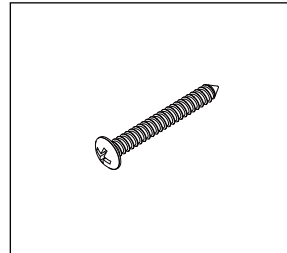

Short Screw

TOOLS REQUIRED

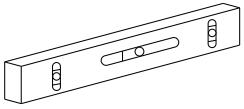

Level Ruler



Marker

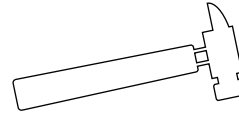

Hammer

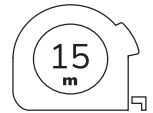

Tape Measure

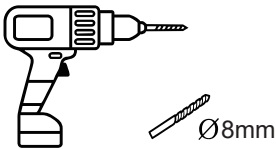

Electric Drill

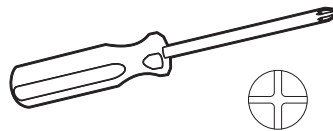

Phillips Screwdriver

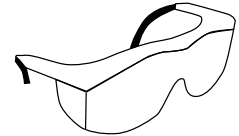

Safety Goggles

BEFORE INSTALLATION

To ensure the best experience, please read carefully and follow the instructions provided below before assembling and installing the product.

1. Important safety Instructions:

- Assemble the product by two or more adults to ensure proper installation.
- To connect the wires to electrical junction box, consultation with a qualified technician or electrician is highly recommended.
- Disconnect power before installing, adding, or changing any components.
- Make sure that the fixing location can support the weight of the entire fixture (e.g. solid stone or brick walls).

- To prevent injury, the mirror must be installed according to the instructions provided

2.Pre-assembly:

- Inspect the product immediately upon receipt for any transit damage or missing parts.
- The voltage for your product should be between 220V and 240V.
- Please do not remove the plastic corner guards and transparent film on the mirror until the installation is finished.

3.Before Installation:

- Please check and make sure that the mirror is functioning properly.

• Power Check

After powering on,the backlight of buttons will activate automatically.

• Touch Switch



The button control the light brightness and color temperature.Keep holding it and the brightness will change . You can adjust the color temperature as well :the first tap is warm light, the second one isnatural light,and the third one is white light .If no button is pressed within 5 seconds, the next tap will turn off the light immediately.

• Memory Function

Your current settings will be saved,and it will resume in the same settings when you turn it on again.

• Anti-fog

The anti-fog function helps resist the troubling fog and keep a clear reflection image.To save energy,it will automatically turn off after one hour.

INSTRUCTIONS

1. Measure the distance between the two bracket holes on the back of the mirror (called A distance)

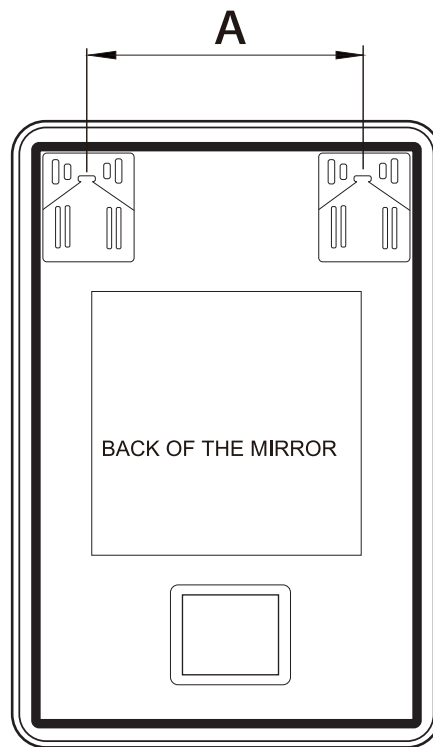

Vertical Mounting

2. Use a level to draw a horizontal line on the wall at the height where the mirror will be mounted. Ensure that the length of this line is equal to Distance A.

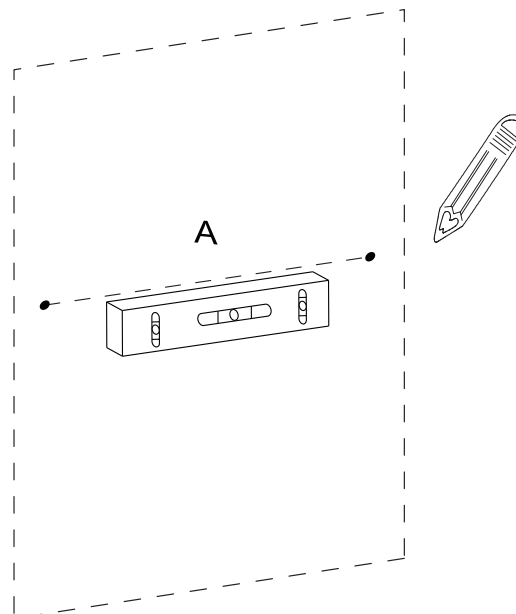

3. Mark the drilling position at both ends of the horizontal line with a marker.

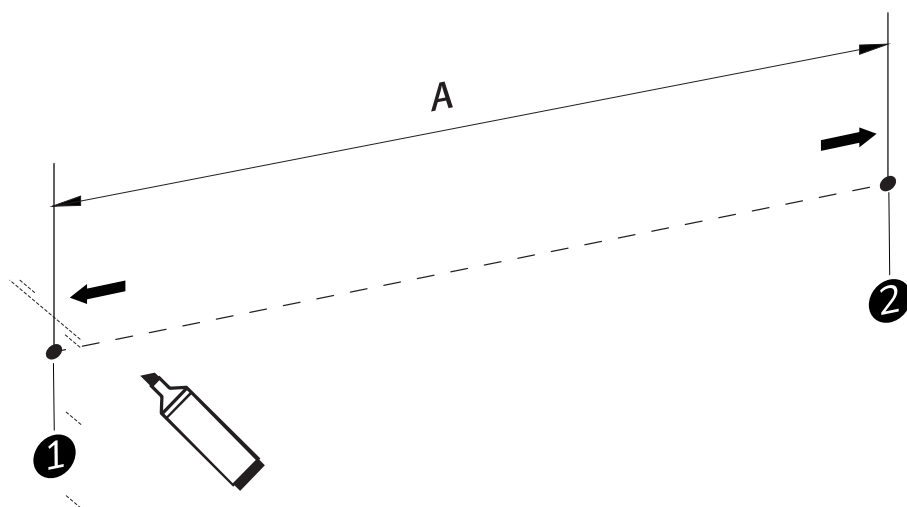

4. Use an electric drill to punch holes at the marked spots, and then install the expansion screw with a hammer.

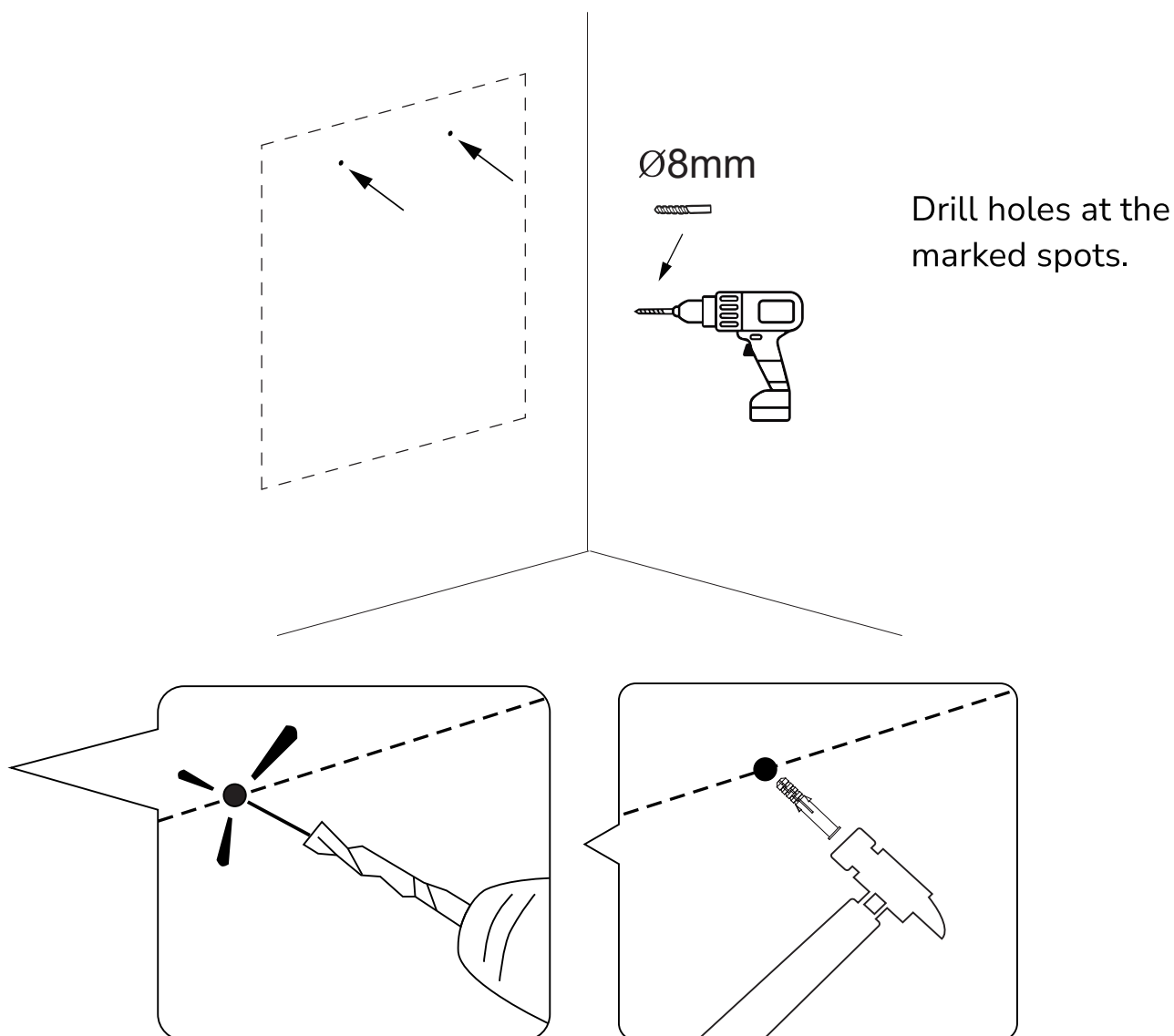

5. Screw the two brackets to the wall.

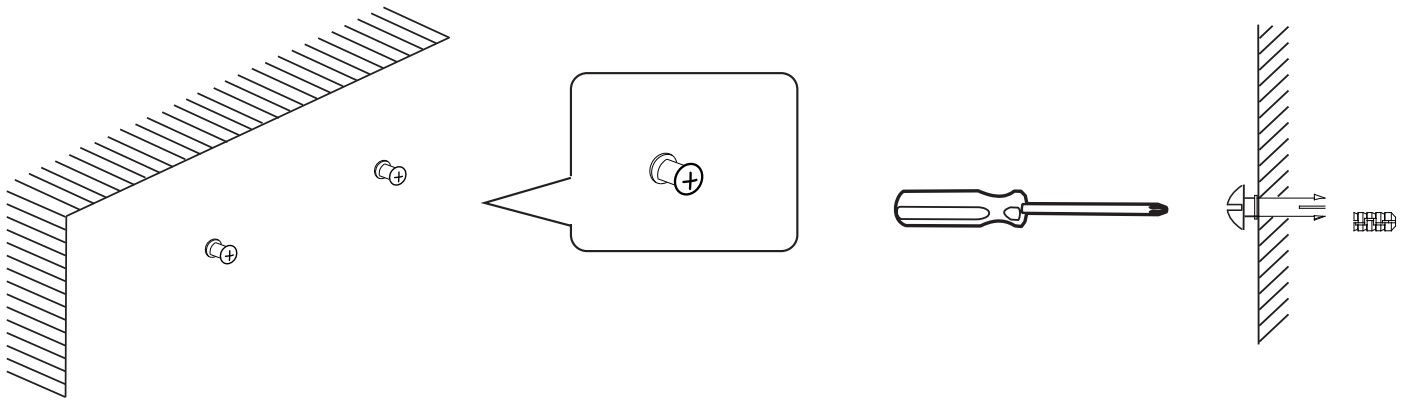

6. Connect the power cord to the standard circuit board by hard connection

**Brown wire---power supply L (LIVE)
Blue wire---power supply N (NEUTRAL)**

! REMINDER: Please make sure the power is cut off before installation.

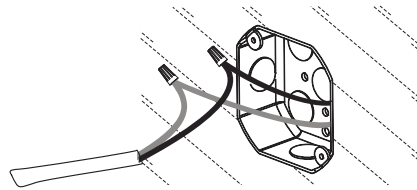

7. Place the mirror against the wall, align the hook with the mounted bracket, slowly lower the mirror down, and make sure that it slots into the right position and hangs securely.

