

Installation Manual

Please keep this page for your online registration.

No. FIRDRDA12V1.0





CAUTION

1. Follow installation instructions carefully to ensure unit is properly attached to the wall.
2. To avoid a possible fire hazard, it is essential unit is mounted in accordance with guidelines stated in the instruction.
3. Radiator is intended for indoor use only, do not place radiator inside a shower, steam room, or wherever unit would be exposed to water.

TECHNICAL DATA

It should only be filled with water, and at a temperature below 100°C (212°F). See table below for installation requirements. If the temperature exceeds 48°C (or 120°F), please install a warning sign near the product to avoid burning and scolding accidents.

Temperature: $0^{\circ}\text{C} < t \leq 100^{\circ}\text{C}$

Comments: If ambient temperature drops below 1°C, drain out the water to prevent freezing.

Important

Wipe the surface clean with a soft, damp cloth. Never use abrasive cleaners on this product as they will damage the surface.

TOOLS YOU MIGHT NEED

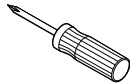

Screwdriver



Pencil



Adjustable Wrench



Rubber Hammer



Glove



Tape Measure



Spirit Level

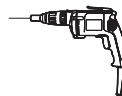

Electric Drill



Clean Cloth

IMPORTANT CHILD SAFETY NOTE

Important: Please note that you are 100% legally responsible for your own child's safety at home. Once the radiator is installed, it can become a hazard for children as a) This radiator is not designed to support unreasonable extra weight, such as that of a child, and b) The radiator becomes hot during use. Due to this, we must stress that you should not allow children to climb/grab/play with the radiator or rails, as this can cause accident or injury for the child, from heat, falling, or the radiator being pulled off the wall.

BEFORE INSTALLATION

- Observe all local plumbing and building codes.
- Shut off the main water supply.
- Read these instructions carefully to ensure proper installation.
- Check to make sure you have the following parts indicated below.



CAUTION

Please check you have all of these items in the box.

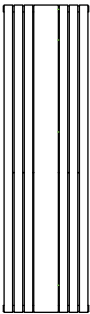

Body
X1



Airvent
X1



Blanking plug
X1



Washer
X8



Silicone Gasket
X4



Wall Bracker
X4



Masonry Wall Plug
X8

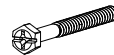

Long Screw
X8

INSTALLATION PROCEDURE

1

Position the towel rail in desired location check for level and mark four equal positions for the brackets.



Make sure the towel rail is installed vertically.



Before installation place a dust sheet on the floor to prevent losing any small parts.

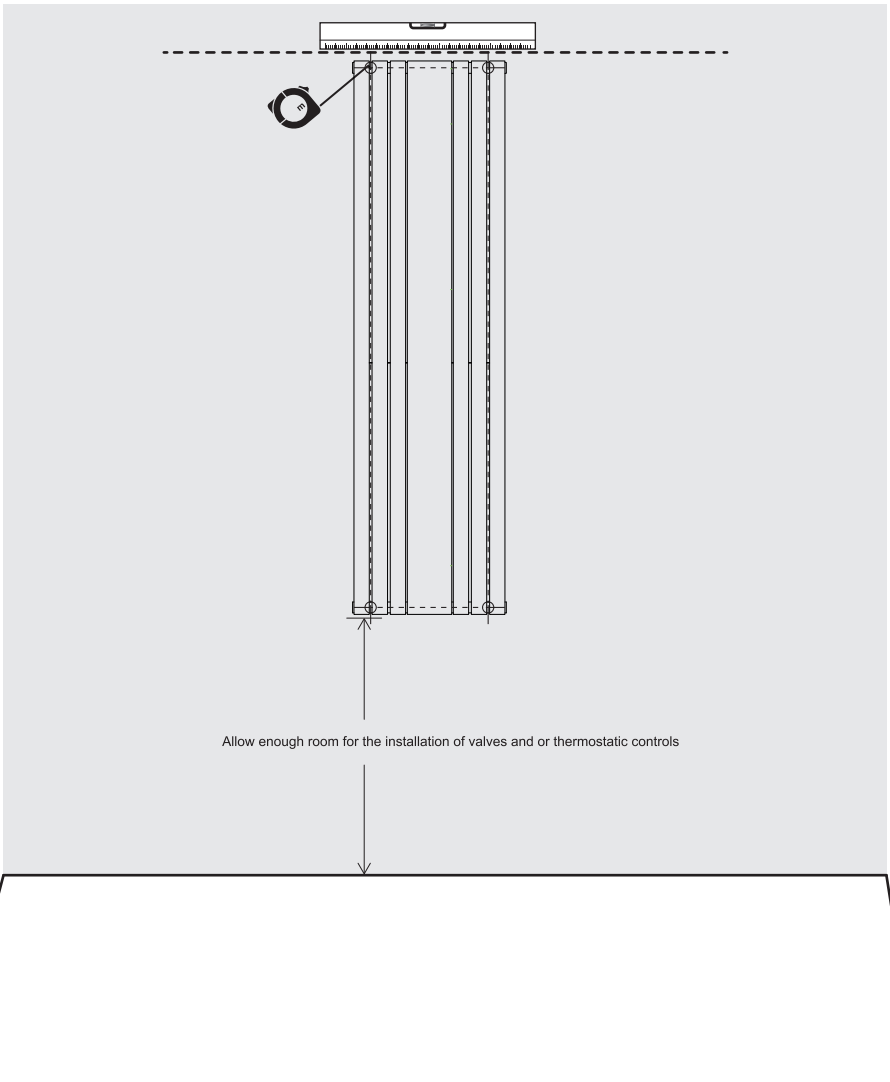

INSTALLATION PROCEDURE

2

Drill holes in wall and insert wall plugs. N.B For false or studded walls different fixings can be purchased from your local DIY store.

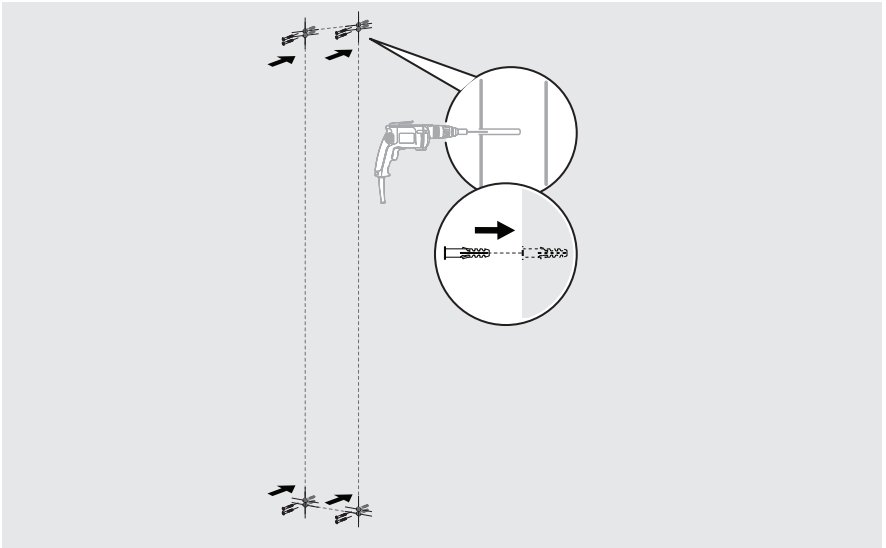

3

Fix the brackets to the wall and insert the silicon gasket into the hook part of the bracket.

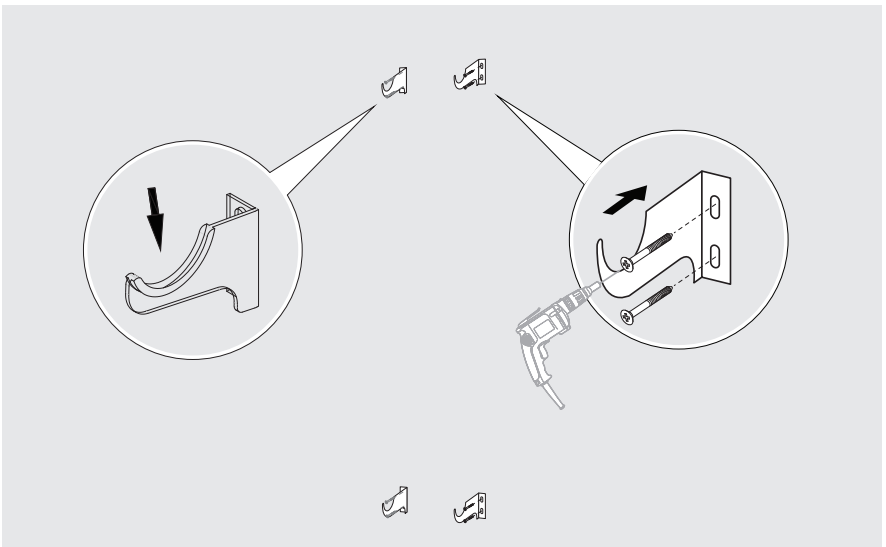

INSTALLATION PROCEDURE

4

Wrap PTFE tape around blanking plug and bleeder valve and screw into top or radiator tighten with a spanner.

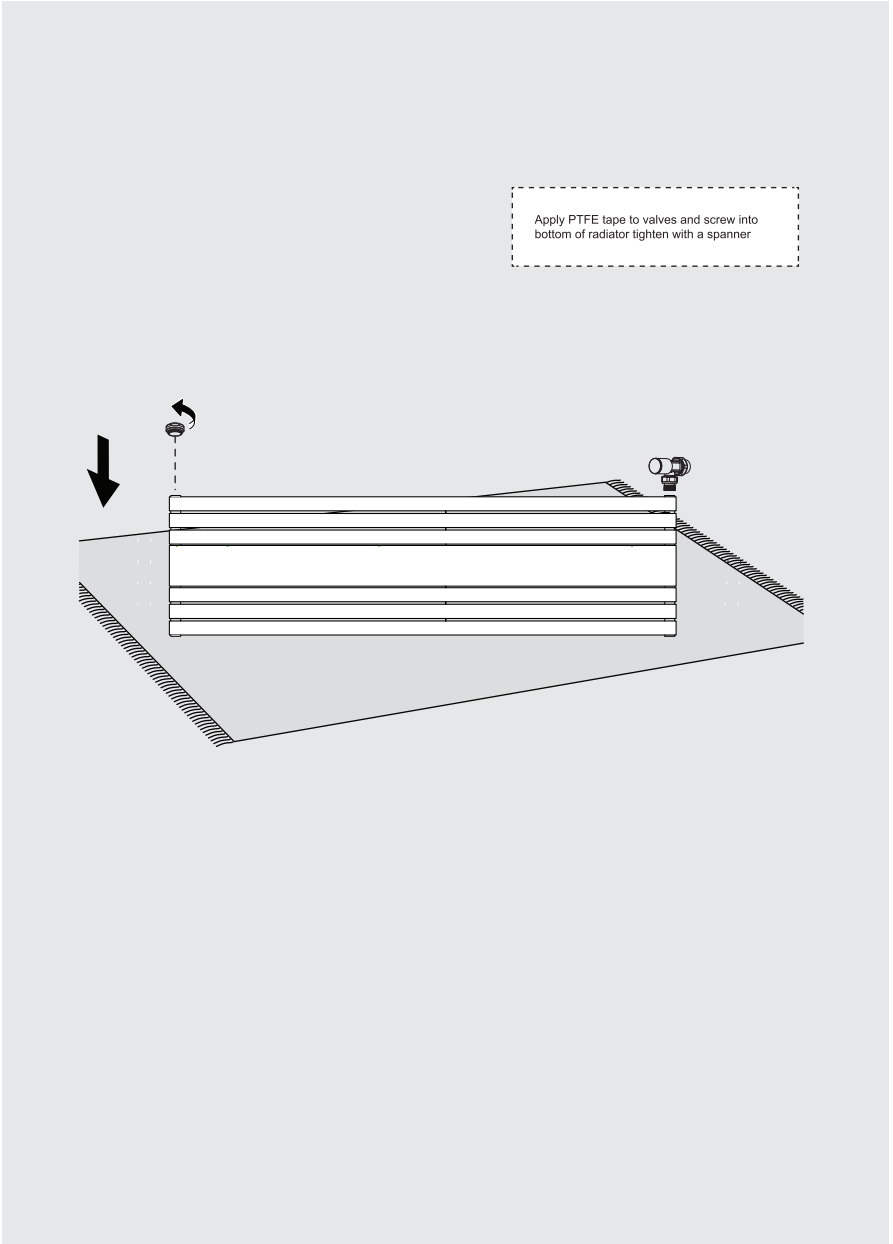

INSTALLATION PROCEDURE

5

Rest radiator onto brackets and connect valves to household supply.

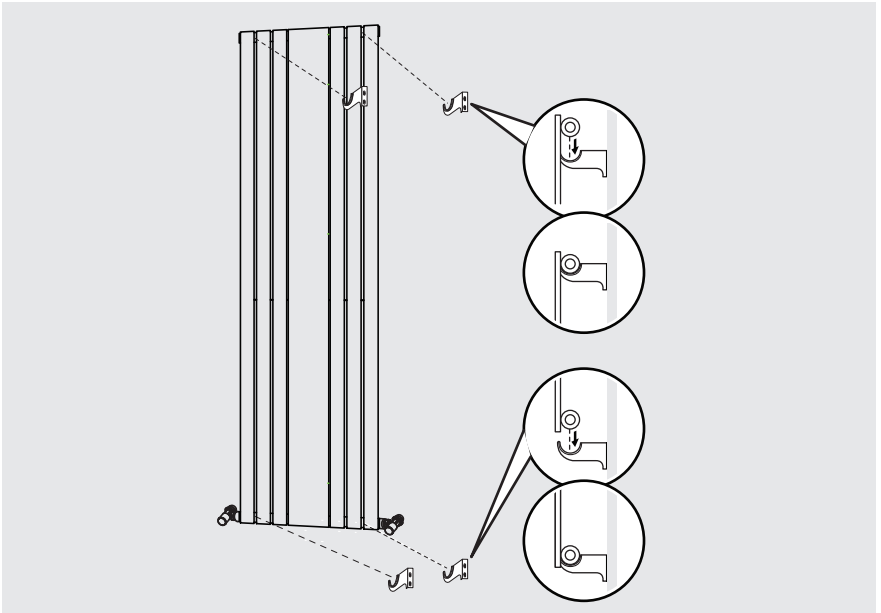

Connect valves to household system, turn on water and bleed the radiator to fill with water.

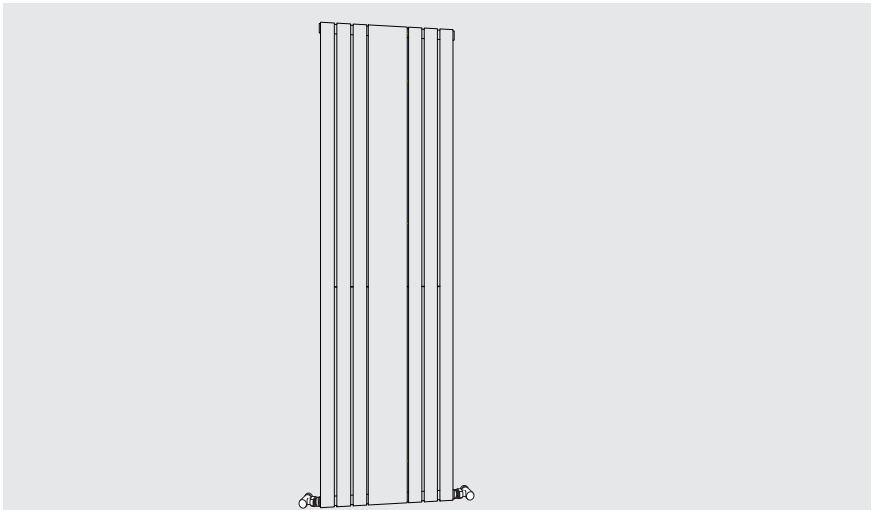

Note: Top up your system with inhibitor fluid after installation

AFTER INSTALLATION

Use a screwdriver to open the air vent,open the valve and let the water rush into radiator.

Check all connection for leaks.

Once water overflows from the air vent,there is no air in the tube.

Use a screwdriver to close the air vent,turn on the valve and the radiator is ready for use.

CARE & CLEANING

Radiators are made from steel and should not be cleaned with corrosive or scouring cleaning agents.

TROUBLE SHOOTING

When your radiator doesn't function, knowing basic radiator troubleshooting can save you from the stress and the hassles of a non-functioning radiator. Here is a guide to solve the most common problems associated with these electric home heaters.

| Problem | Cause | Action |
|---------------------------------------|--|--|
| Cold spots on the radiator unit | -Water is not flowing through radiator properly | 1.Check to make sure there is no trapped air inside the radiator. "Bleed" the radiator to release air. 2.Make sure the valve is fully open to allow water to run freely. Some radiator may need diverter for water to flow properly around the unit. |
| Leak on the radiator | -Valve nut is loose -Welding problem | -Tighten the valve nut -Replace radiator |
| Sound of whistling or water whooshing | -Radiator was not properly balanced when it was installed | -Re-install |
| Clanking sound | -The radiator was installed in a space that doesn't allow for pipe expansion | -Re-install |