

Installation Manual

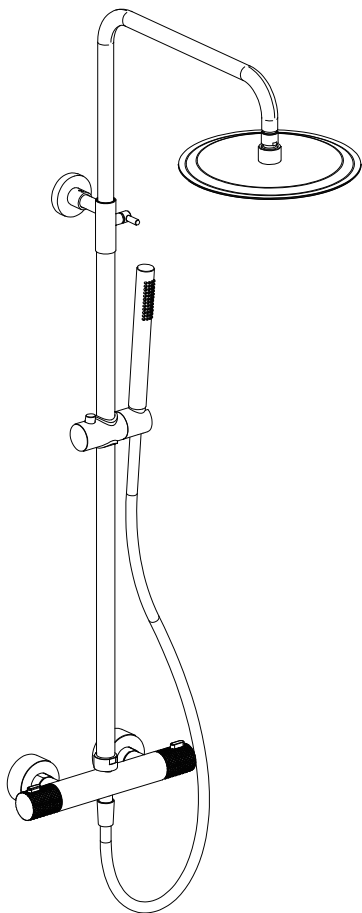

Apply for following models

23059/23060/23061/23062/23063

Please keep this page for your online registration.

No. **FISHTBK01V1.0**



TECHNICAL DATA

Conditions of use for thermostatic mixer valves.

	Scope of Use	Recommended Range Proper Use
Dynamic Pressure(bar)	Min 1bar	1bar ≤ P ≤ 5bar
Static Pressure(bar)	Max 10bar	—
Hot Water Temperature(°C)	T ≤ 90°C	55°C ≤ T ≤ 65°C
Cold Water Temperature(°C)	T ≤ 25°C	T ≤ 25°C

TOOLS YOU MIGHT NEED

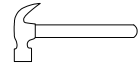

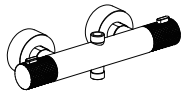

[01]x1



[02]x2



[03]x2



[04]x2



[05]x1



[06]x1



[07]x1

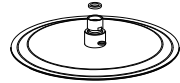

[08]x1



[09]x1

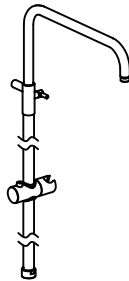

[10]x1



[11]x1



[12]x1



[13]x1

NO.	DESCRIPTION
1	Body
2	Connectors
3	Wall covers
4	Filter washers
5	Wall plug
6	Screw
7	Bracket
8	Top head shower
9	Handheld shower
10	Sliding rail
11	Washer
12	Shower hose
13	Screw

INTRODUCTION

Please read these instructions carefully and keep in a safe place for future reference.

General Installation Requirements

The installation must comply with regulations of the Local Water Authority as contained in their bylaws. The valve in this range is single flow (the hot and cold water mix in the body) and should therefore be supplied with hot and cold water at balanced pressures, both from the tank or both from the mains (via a combination boiler for example). If the valve is not supplied at balanced pressures then the mixer will not function correctly. It will also be necessary to fit non-return valves on both hot and cold feeds. It is very important that all pipe work is flushed thoroughly after installation to avoid damaging the ceramic discs.

Minimum/Maximum working pressure

This valve is suitable for high pressure installations and is fitted with a ceramic disc cartridge which provides a good flow rate with very smooth movement. The maximum water pressure is 10 bar (note: main cold water is normally supplied at between 2 and 3 bar). The required minimum water pressure is 1 bar.

For installations where the mains pressure exceeds 5 bar a pressure reducing valve should be fitted.

WARNING

Before installing the new mixer it is essential that you thoroughly flush through the supply pipes in order to remove any remaining swarf, solder or other impurities. Failure to carry out this simple procedure could cause problems or damage to the workings of the mixer.

These hints have been prepared for your guidance, you must exercise due care at all times. We do not accept responsibility for any problems that may occur through incorrect installation.

INSTALLATION

First shut off your water heating system then, with your mains stop cock closed, open the lowest hot and cold taps in the house and allow to run until the cold storage tank and pipes are empty (the hot water storage cylinder always remains full).

Where combination boilers are fitted it is only necessary to turn off the boiler and shut off the incoming mains.

Fitting non-return isolating valves to the inlet feeds is recommended for ease of maintenance.

INSTALLATION



Remember to turn off the mains water supply before connecting to any existing pipe work.



Warning! Please check for any hidden pipes and cables before drilling holes in the wall.

Preparing the pipe work.

As the valve has no means of fixing to the wall it needs to be supported on rigid pipe work, or by using a fast fix connection bracket (not supplied)

Prepare the supply pipes (hot on the left and cold on the right) at the required height with a width of 150mm centres, making the ends of the adaptors (not supplied) level with the face of the wall, see fig 1.

Screw each 'S' connector into the adaptors in the wall see fig 2.

Valve.

Screw a cover onto each of the 'S' connectors, place a washer into each of the inlets in the valve body. Mount the body onto the "S" connectors and tighten taking care not to damage the surface of the valve.

ATTENTION

Having first checked all new connections, turn on the mains stop cock, close all taps except the new valves and as the system starts to refill check for leaks.

Once you have satisfied yourself that there are no leaks, switch on the water heating.

TROUBLE SHOOTING

SYMPTOM	SOLUTION
After installation the shower/bath runs HOT or COLD and will not mix.	Hot and cold supplies are plumbed the wrong way round.
Shower/bath will not run hot enough when first installed.	Maximum temperature needs adjusting, see 'temperature setting'.
Cold water tracking through the valve into the hot water system.	Check and clean the filters.
Very low flow or no flow (gravity).	Check hot and cold feeds (the valve will shut down if either the hot or cold supply fails).

This product should only be fitted by a qualified plumber to NVQ (National Vocational Qualification) or SNVQ (Scottish National Vocational Qualification) Level 3. Should the installation be completed by a non-qualified person then the guarantee may be considered invalid.

For a claim made under our warranty written certification of your installers credentials can be required. For further information or to find a qualified installer in your area please visit the Institute of Plumbers website - www.ciphe.org.uk

INSTALLATION PROCEDURE

1



[02]

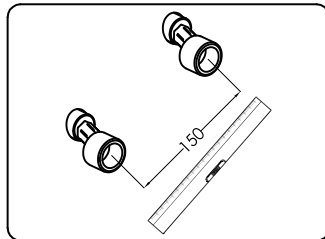
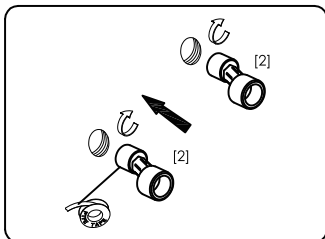

INSTALLATION PROCEDURE

2



[03]



[04]

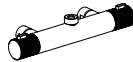

[01]

Pipework should be flushed through before attaching the mixer body to prevent debris from going into the mixer

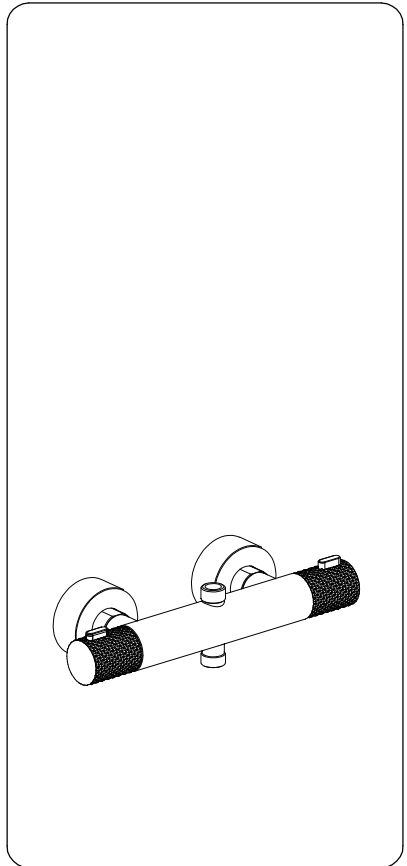
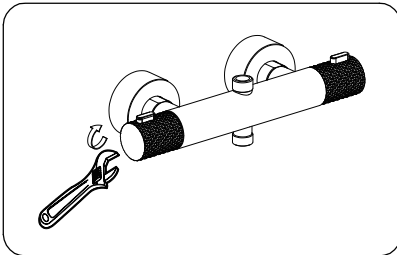
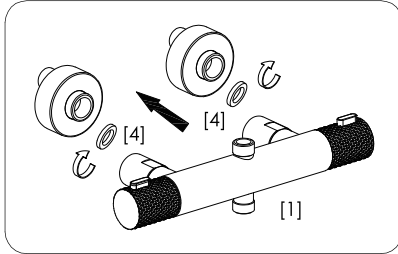
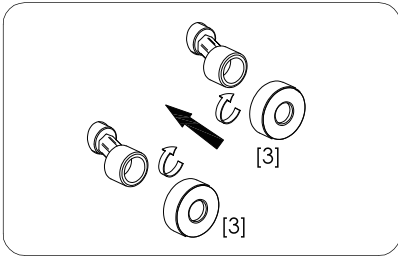

INSTALLATION PROCEDURE

3



[07]

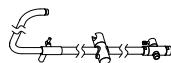

[10]

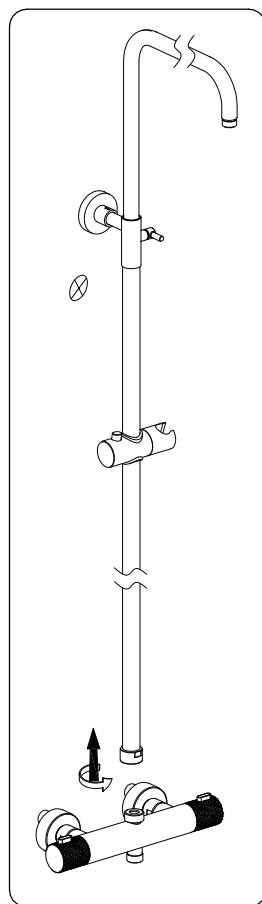
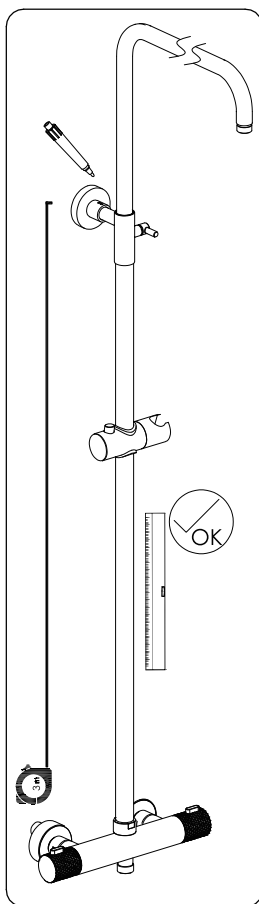
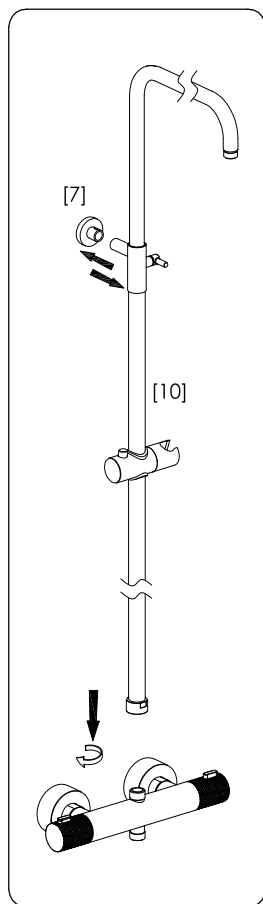

INSTALLATION PROCEDURE

4



∅ 8mm



[05]



[06]



[07]

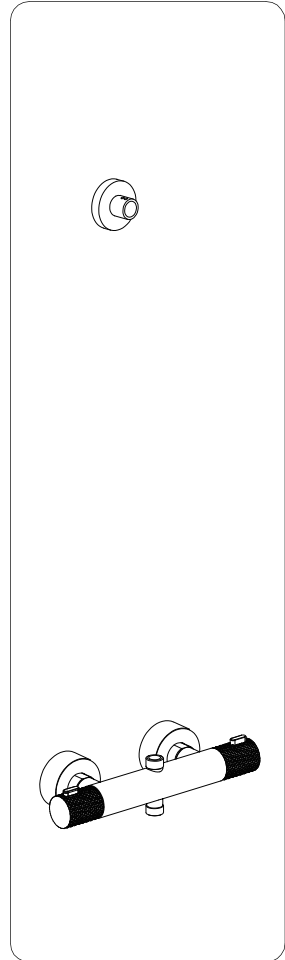
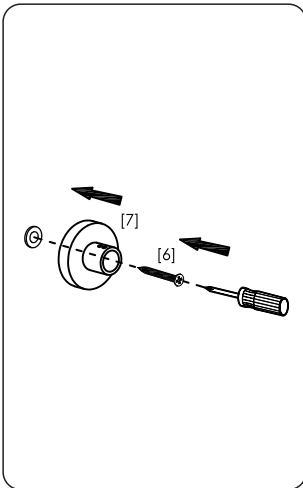
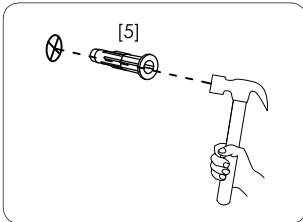
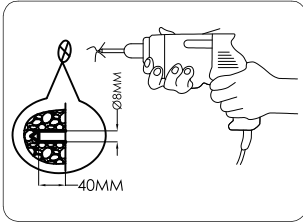

INSTALLATION PROCEDURE

5



[12]

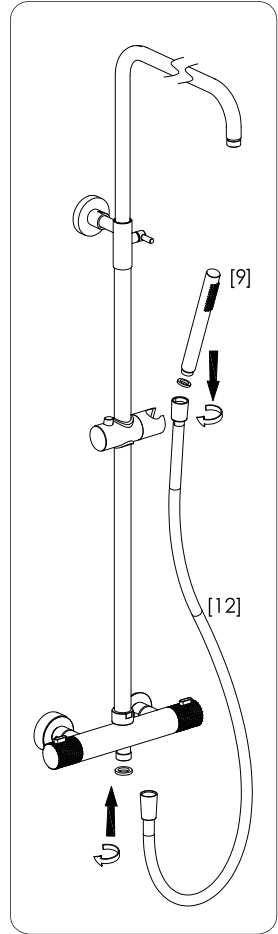
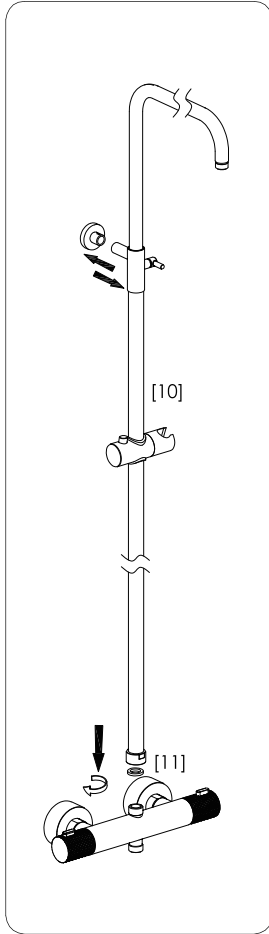

INSTALLATION PROCEDURE

6



[08]

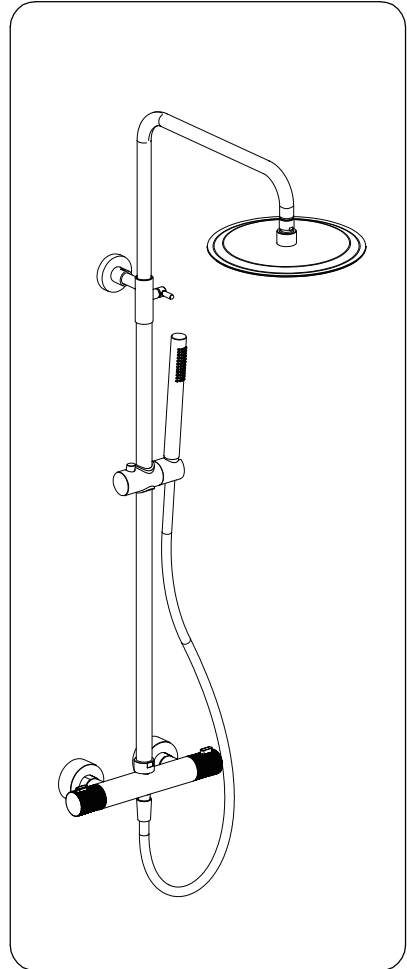
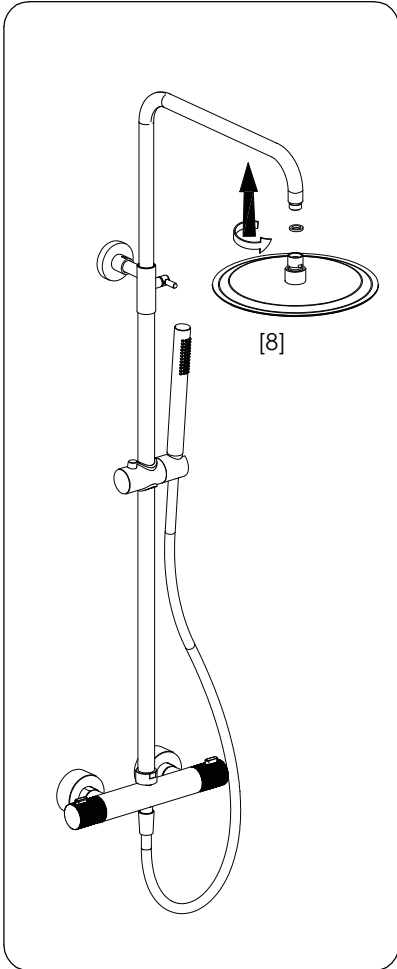

OPEN INLET VALVE

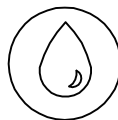
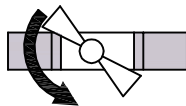

OPERATION

Turn the Function shift handle to turn on top head shower, hand held shower and to increase/decrease the flow of water, Turn the Temperature control handle to increase/decrease the temperature, Push down on the Override button and turn the handle anti-clockwise to override the set temperature

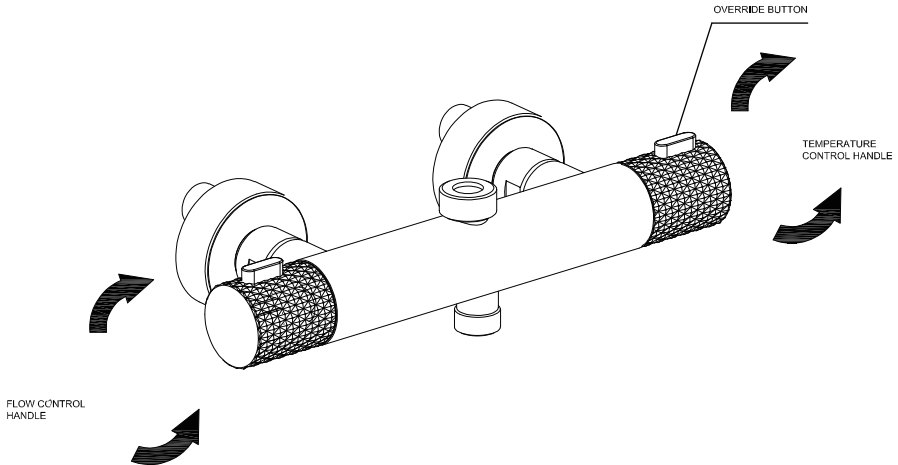

TEMPERATURE SETTING

Removing the handle.

Rotate the exposed thermostatic spindle (clockwise for cold, and anti-clockwise for hot) until the maximum desired showering temperature is set (38°C - suggested maximum "pre-set" temperature).

Then line up the button on the top of the handle/cover with the stop on the stop ring itself. Push the handle/cover onto the splines, tighten the screw, refit the cap.

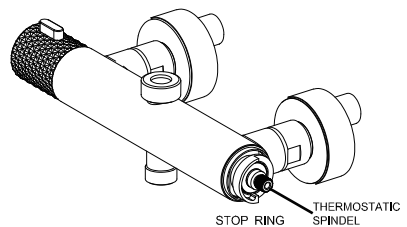

The thermostat is now set to its new temperature and can only be increased or decreased by repeating this process.

MAINTENANCE

Before carrying out any maintenance please remember to turn OFF all mains water and turn ON the isolating valves.

THERMOSTATIC CARTRIDGES

The thermostatic valve should give trouble free service, but in the event of failure, servicing is straight forward.

To remove the thermostatic cartridge.

Remove the handle - see image, use an allen key to remove the screw first, then remove the handle and stop ring.

Carefully using the correct size allen key unscrew and remove the cartridge.

Wash the cartridge with clean running water and make sure that any trapped debris has been removed. Dry and lightly grease the seals (only use silicone grease). Screw the cartridge back into the body, replace the stop ring (if removed) making sure that the stop is at the 12 o'clock position.

Push the handle onto the splines, tighten the screw, refit the handle.

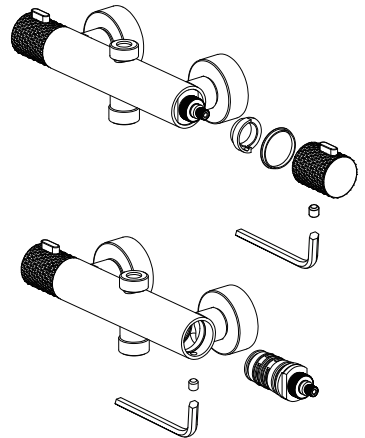

FLOW CONTROL CARTRIDGE

The Flow Control Cartridge uses ceramic discs which normally last indefinitely unless debris manages to get between them. Wash the cartridge with clean running water, dry and lightly grease the seal.

FILTERS

Turn off water supply to the valve and remove from the wall. Using a 28mm hexagonal key undo the retaining nut within each of the inlets. Wash the filters with clean running water and replace.

CLEANING

CARE OF YOUR SHOWER VALVE

We recommend cleaning the valve with a soft damp cloth. We strongly advise against the use of ALL cleaning products.