

Installation Manual

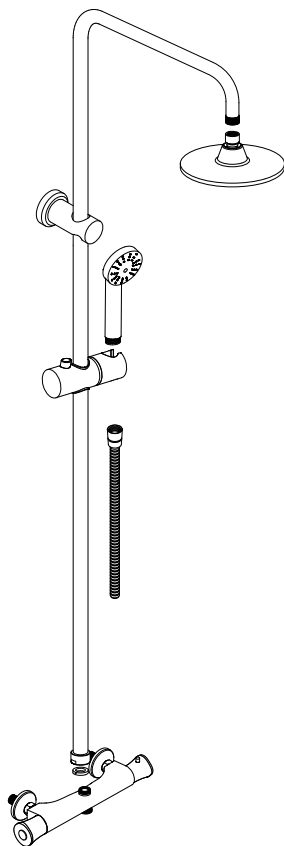

Apply for following models
23002

Please keep this page for your online registration.

FISHTBL118V1.0



WARNING



CAUTION

Flush all pipe work through before connecting the tap, debris in the pipe work can block the cartridge and lead to damage.

TOOLS

YOU MIGHT NEED

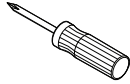

Screwdriver

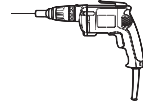

Electric Drill



Adjustable Wrench



Hexagon wrench

TECHNICAL DATA

Flow Rate L/P Min						
Bar	0.2	0.5	1.0	1.5	2.0	3.0
23002	3.6	5.8	8.3	10	11.7	14.4

Please know and follow all applicable local plumbing codes when setting the temperature on the water heater.

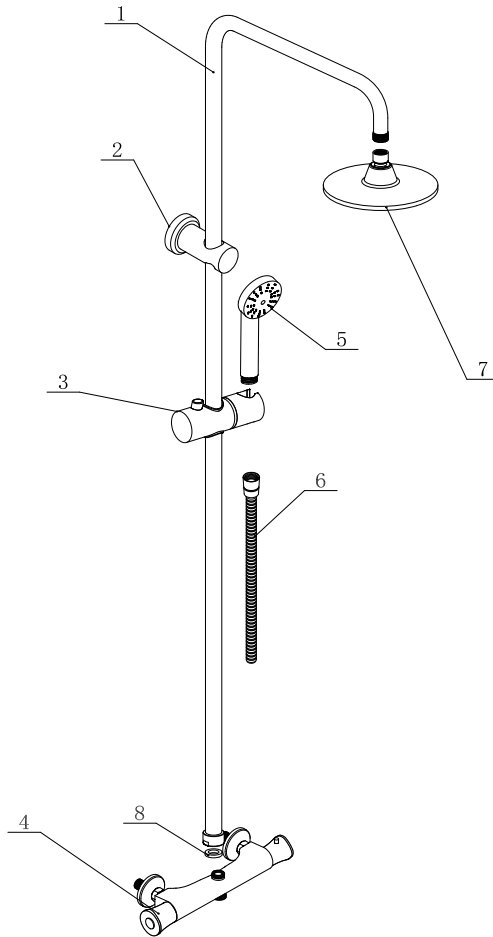

PART LIST

1	SS RISER RAIL	5	HEADSHOWER
2	WALL BRACKET	6	SS HOSE
3	HOLDER	7	HANDSHOWER
4	BODY	8	GASKET





BEFORE INSTALLATION

- Observe all local plumbing codes.
- Make sure water supply is turned off.
- Read these instructions carefully to ensure proper installation.
- Cover your drain to avoid losing parts.
- Check to make sure you have the following parts indicated below.

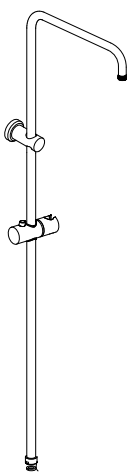

CAUTION

Please check you have all of these items in the box.

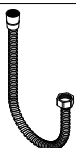
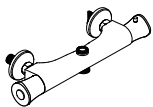
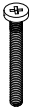
 <p>Body X1</p>	 <p>Hand Shower X1</p>	 <p>Head Shower X1</p>
	 <p>Wall Plug X2</p>	 <p>Shower Hose X1</p>
	 <p>Body X1</p>	 <p>Screw X2</p>

INSTALLATION PROCEDURE

1

Remove the plastic backnut and washers from the water inlets.

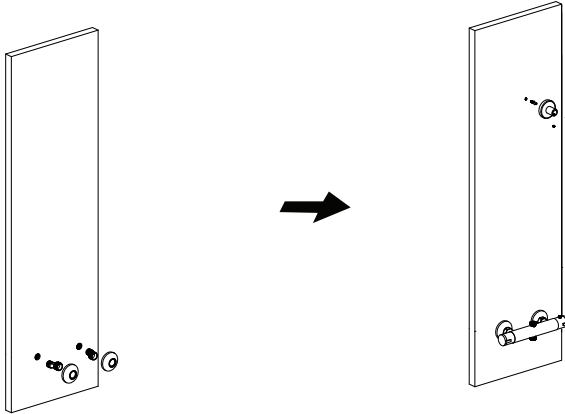

2

Carefully assembly fitting on to the wall .ensuring the rubber washer or rubber cushions are in the place at the base of the fitting.Tighten the backnuts.ensuring equal torque is applied to both nuts.

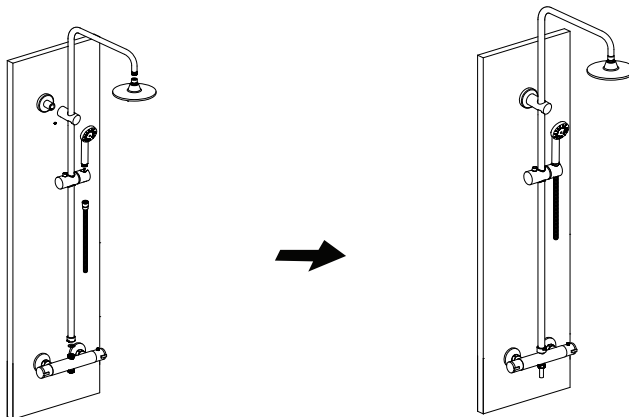

CONNECT WITH HOT WATER PIPE

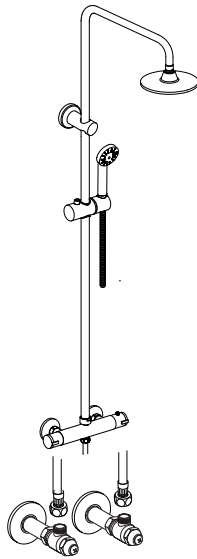

CONNECT WITH COLD WATER PIPE



AFTER INSTALLATION

Ensure that all connections are tight. Ensure that the handle is in the off position. Turn on the drain and main water supply, and check for leaks. Repair as needed.

CARE & CLEANING

Your new tap is designed for years of trouble-free performance. Keep it looking new by cleaning it periodically with mild soap, rinse thoroughly with warm water and dry with a clean, soft cloth. Do not use abrasive cleaners, steel wool or harsh chemicals, as these will dull the finish. Failure to follow these instructions may void your warranty.

TROUBLE SHOOTING

If you've followed the instructions carefully and your tap still does not work properly, take these corrective steps.

Problem	Possible Cause	Solution
Insufficient water	- Aerator clogged	- Clean aerator, replace if necessary
Mixer stiff	- Cartridge defective	- Replace cartridge
Mixer dripping	- Cartridge defective	- Replace cartridge
Water leaks below handle	- Cartridge defective	- Replace cartridge
	- O-ring/rings defective	- Replace O-ring/rings
Water leaks at the connection	- Loose connection	- Tighten connection