

Installation Manual

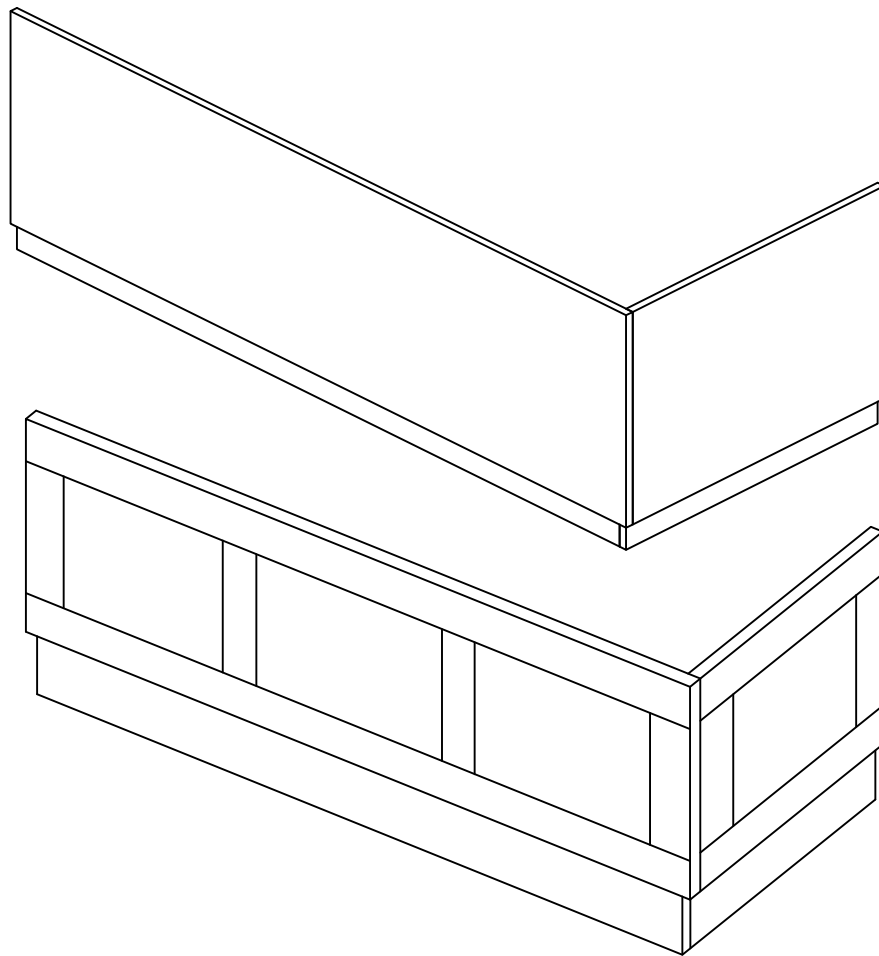

Apply for following models:

55031/55032/55033/55034/55035/55036/
55037/55038/55039/55043/55044 /55045/
55046/55047/55107/55108/55109/55110/
55111/55112/55121/55122

Please keep this page for your online registration.

No. FIFUMCU001V3.0



Tools required(Tools not provided)

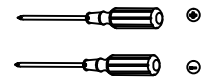
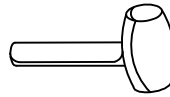

Spirit Level

Hammer

Pencil

Screw Driver

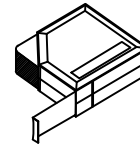
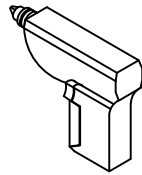
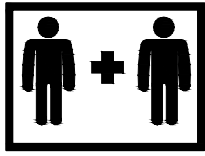

Electric Drill

Drill Bit

Tape



Please check you have all of these items in the box.
- dependant on your purchase



Front Panel



Ø4x25mm



Plinth

8 PCS

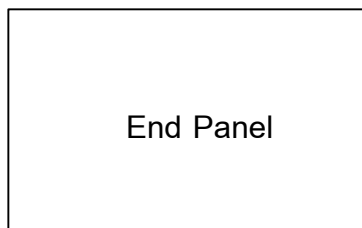

End Panel

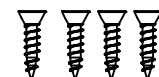
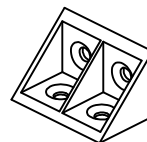

Ø3.5x14mm

4 PCS

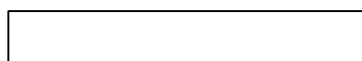

Plinth

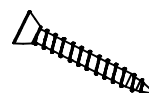

Ø4x25mm

4 PCS

INSTALLATION PROCEDURE

1. Measure from the underside of the bath rim to the floor to establish the height of the bath panel required.
2. Drill equally spaced holes along the plinth and screw to the bottom edge of the main panel at the desired height.
3. It is advisable that you build a frame or fit battens along the floor and down the wall sides to support the panel.
4. When an end panel is used it will be necessary to trim the width. Any trimming should be done at the wall end to ensure that the finished edge is at the visible corner. The front and end panels are fixed together using the brackets and screws provided in the end panel box.
5. Any cut or trimmed edges should be sealed to prevent water ingress. It is also advisable to seal all the outer edges of the panels.

