

BASIN INSTRUCTION

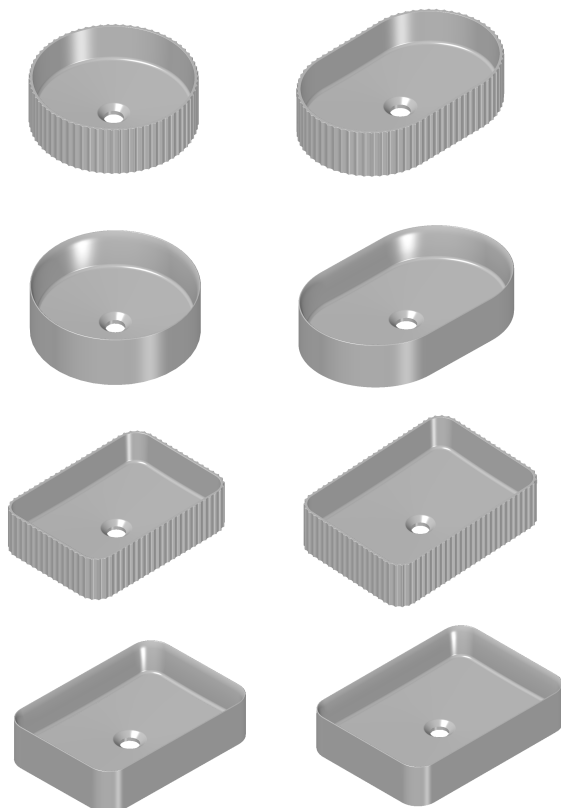

63219 63220
63223 63224
63221 63222
63225 63226



This instruction must be given to the user.

Guarantee/Liability only when assembled by an approved specialist in accordance with the instructions and local regulations.

INSTALLATION INSTRUCTIONS

TOOL



Spirit level



Ruler



Pencil



Silicon sealant

Step1:

Place the basin firmly on the countertop, and fit the drain hole of the basin into the hole on the countertop.

Note: It is recommended to re-dress the basin before fitting the basin to the counter-top.

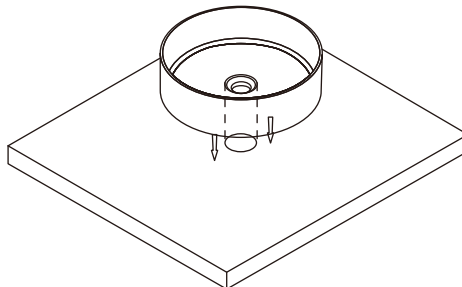

INSTALLATION INSTRUCTIONS

Step2:

Apply a layer of high-quality silicone sealant around the edge of the basin.

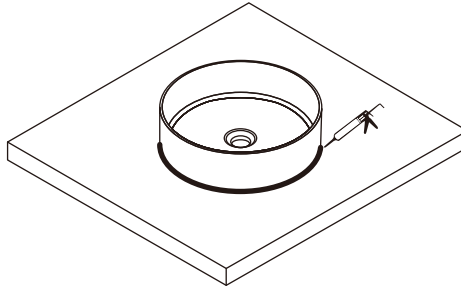

Step3:

Wipe away any excess silicone with a damp cloth and allow 24 hours for the sealant to fully dry. Ensure all parts are level using a spirit level.

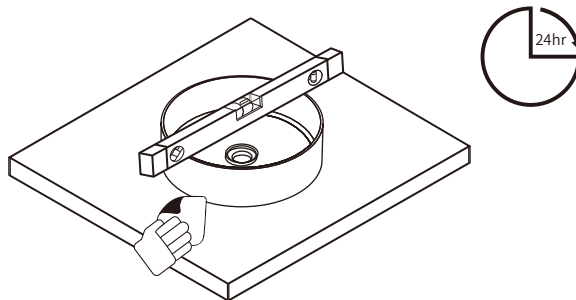























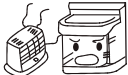

Cleaning and Maintenance:

We recommend that you regularly clean your basin with a sponge. After each use, wipe the basin dry with a soft cloth. Do not allow mineral deposits such as iron, salt, lime, or soap to build up on your basin. Refrain from using acidic household cleaners, wipes with harsh chemicals, or abrasives, as these will damage the basin.

Recycling and Disposal:

Please recycle the packaging in accordance with your local government regulations on waste handling and follow the same advice at the end of the products life.

USER MAINTENANCE

<p>KEEP CABINET AWAY FROM WATER, which will cause deformation and damage.</p> <p>  </p> <p>CAUTION</p>	<p>DO NOT put lit cigarettes on the counter or basin, which will cause discoloration.</p> <p>  </p> <p>CAUTION</p>
<p>DO NOT pour acid or alkaline solutions into the basin, which will cause discoloration, leak or damage.</p> <p>  </p> <p>CAUTION</p>	<p>AVOID DIRECT SUNLIGHT, which may cause deformation and discoloration.</p> <p>  </p> <p>CAUTION</p>
<p>AVOID HEAT, which will cause deformation and discoloration.</p> <p>  </p> <p>CAUTION</p>	<p>DO NOT pour hot water into the basin, which may cause damage.</p> <p>  </p> <p>CAUTION</p>
<p>AVOID nylon brush, toilet cleaner or hydrochloric acid cleaner, which will cause damage</p> <p>  </p> <p>CAUTION</p>	<p>AVOID dropping hard objects into the basin, which may cause damage.</p> <p>  </p> <p>CAUTION</p>

To extend the life of the product, please do the maintenance work every day. The following maintenance methods are for reference only.

- Please dry the cabinet immediately with clean, soft cloth when it encounters water.
- When the product is stained with dirt, wipe the cabinets clean with a soft, damp cloth, apply some cleaners, and dry immediately with another clean, soft cloth.
- The water supply pipes, the drainage pipes, and the connection parts are prone to water leakage under different circumstances. Please check these parts regularly to avoid accidents due to water leakage.
- After the product is used for a period of time, dirt will remain on the drain plug, which will affect drainage, so the plug needs to be cleaned regularly.